

## INTRODUCTION

- Car exterior features	1
- Car interior features	2
- Identification data - Location of identification data on vehicle	7
- Dimensions	8
- Weights	9
- Performance - Fuel consumption	10
- Capacities	12
- Characteristics of lubricants	13

## TECHNICAL DATA

### ENGINE

- Characteristics	14
- Power curves	15
- Cylinder block/crankcase, crankshaft and associated components	16
- Counter-balance shafts	20
- Cylinder head and valve gear components	22
- Lubrication	25
- Cooling system - Fuel system - Supercharging	26

CLUTCH	27
--------	----

GEARBOX AND DIFFERENTIAL	28
--------------------------	----

PROPELLER SHAFT	31
-----------------	----

REAR DIFFERENTIAL	32
-------------------	----

BRAKING SYSTEM	34
----------------	----

STEERING	35
----------	----

WHEELS	36
--------	----

FRONT SUSPENSION	37
------------------	----

REAR SUSPENSION	38
-----------------	----

ELECTRICAL EQUIPMENT	39
----------------------	----

- Starting	40
- Recharging	42
- Electronic ignition/injection	44

This publication has been divided into sections headed by two figure numbers which appear in the parts microfiches and in the repair time schedules.

The section titled **INTRODUCTION and TECHNICAL DATA (00.)** has a dual purpose of introducing the model and reinforcing the remaining part of the manual. It contains tables of technical data and information relating to the chapters in the remaining section of the manual.

The remaining sections (10. - 18. etc) include descriptions of the servicing operations.

**NOTE** *The operations involved in removing-refitting the power unit are illustrated in section 10. The procedure for overhauling the engine at the bench is described in a separate booklet which has its own print number. It should be inserted, according to the size of the engine, in the appropriate section, in either the "Overhauling petrol engines" or "Overhauling Diesel engines" binder.*

This publication contains graphic representations and symbols in place of descriptions for mechanical components, operations and servicing techniques. The use of colour for a component or part of one serves to draw the operator's attention to the object to be measured or checked.

Example:

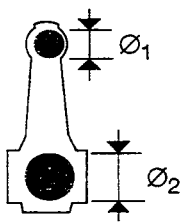

Small end diameter

Big end bearing housing



Tighten to torque

**THIS PUBLICATION HAS BEEN PRODUCED IN A LOOSE LEAF FORMAT TO FACILITATE THE OPERATION OF UPDATING THE MODEL. ANY SUBJECTS DEALT WITH IN THE SERVICE BULLETINS SHOULD BE INSERTED, FROM TIME TO TIME, UNDER THE APPROPRIATE SECTION.**

The **DELTA HF 4WD** is a 2 box saloon with a load carrying structure; it has a 1995 cc 4 cylinder in line engine transversely mounted at the front which runs on super petrol, has an electronic ignition/injection system, is supercharged by a turbocharger and develops a power output of 122 kW (165 bhp).

It has permanently engaged four wheel drive.

Ferguson type viscous joints are fitted to the central differential. The rear differential is the Torsen self-locking type.

















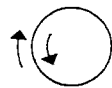





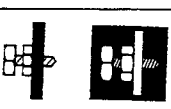
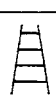









**THE PRISMA 4WD** is a three box saloon with a load carrying structure; it has a 4 cylinder in line 1995 cc engine transversely mounted at the front, runs on super petrol, is equipped with an electronic injection/ignition system and develops a power output of 84.5 kW (115 bhp).

It has permanently engaged four wheel drive.

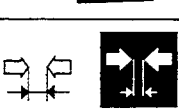
Ferguson type viscous joints are fitted to the central differential. The rear differential has electro-pneumatic engagement for locking.

---

# DELTA-PRISMA 4WD Graphic representations and symbols

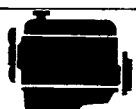
	Remove Disconnect		Operation
	Refit Connect		Tolerance Difference in weight
	Removing Dismantling		Pre-load
	Fitting Reassembly		Rotation
	Tighten to torque		Rolling torque
	Tighten to torque plus angle		Angle Angular value
	Stake nut		Compression ratio
	Adjustment Regulation		Grades Classes
	Visual inspection Check		Oversize Greater than .... Maximum
	Warning		Undersize Smaller than .... Minimum
	Lubricate Grease		Number of revs
	LANCIA LANCIA Replacement Genuine spares		Ratio
	Bleed braking system		Pressure
	Machined surface Finished surface		Temperature
	Interference Force fit		Temperature < 0°C Cold Winter
	Distance to be measured Measurement - Check Thickness - Clearance		Temperature > 0°C Hot Summer
	Inlet		Windscreen wiper with electric washer pump
	Exhaust		Rearscreen wiper with electric washer pump
			Engine



**3/4 front view of DELTA HF 4WD**

As an alternative air vents for cooling the front brakes are fitted in place of the driving lights

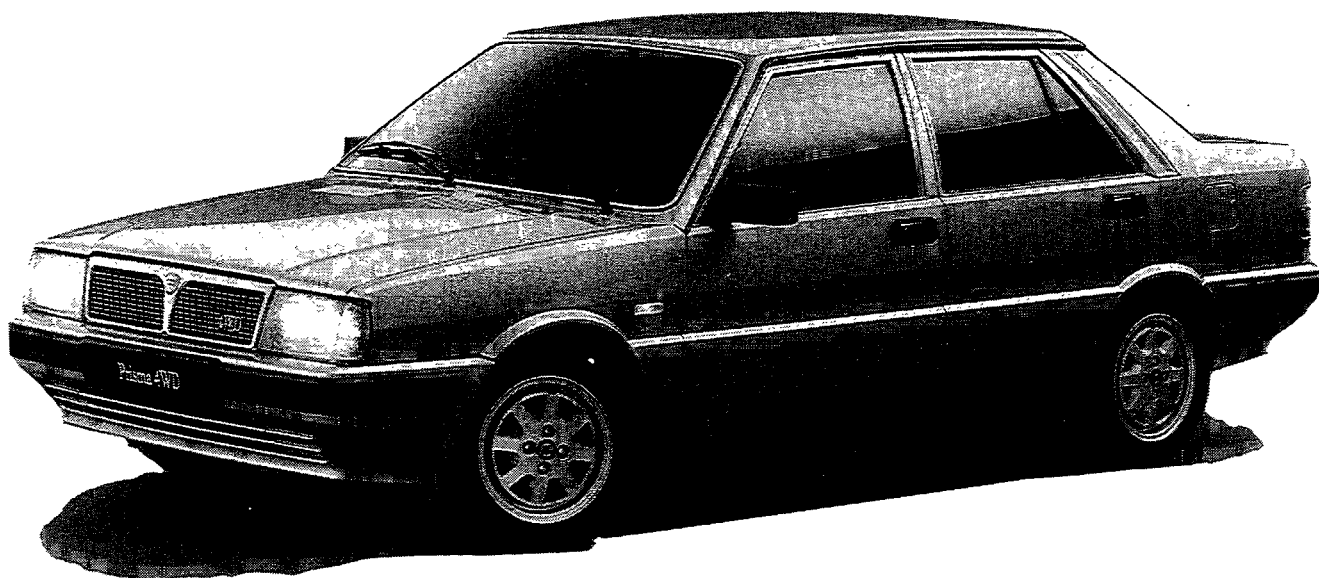

**3/4 front view of PRISMA 4WD**

00.0

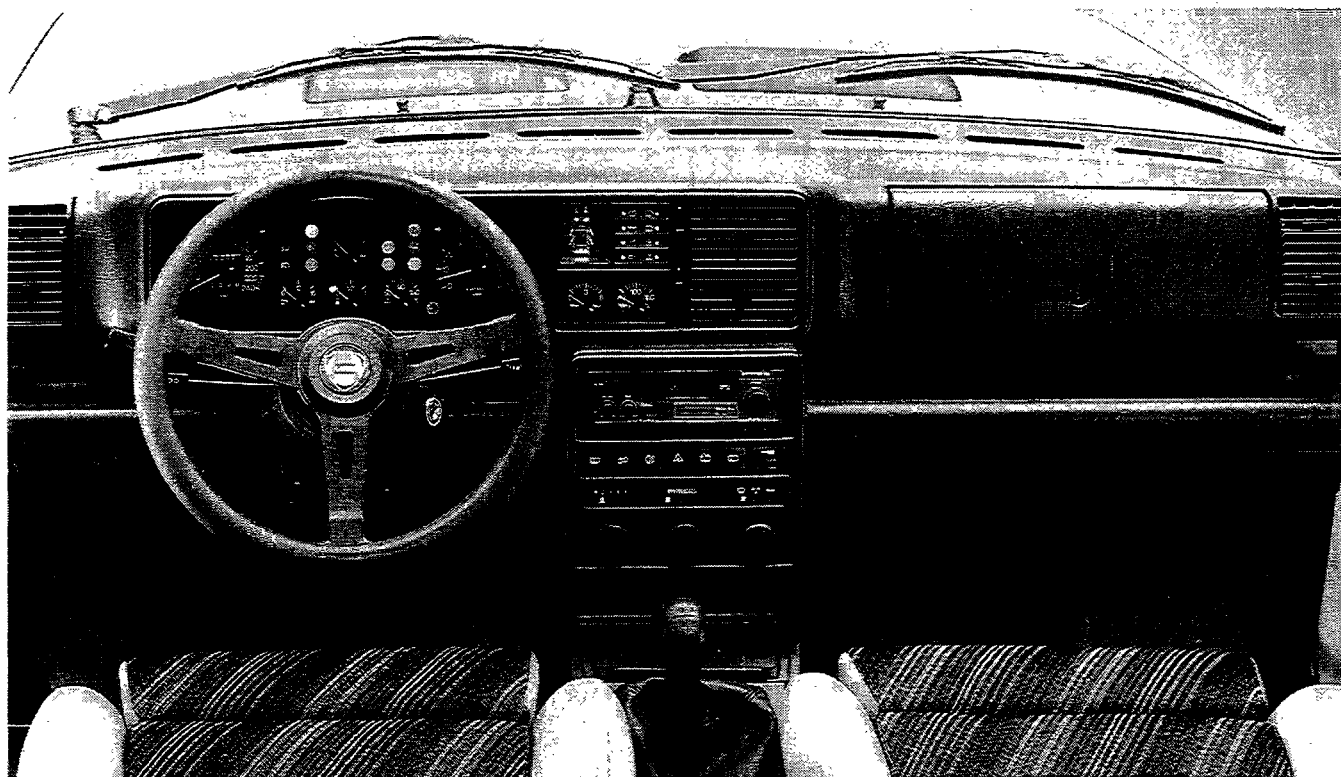

View of the dashboard on the DELTA HF 4WD

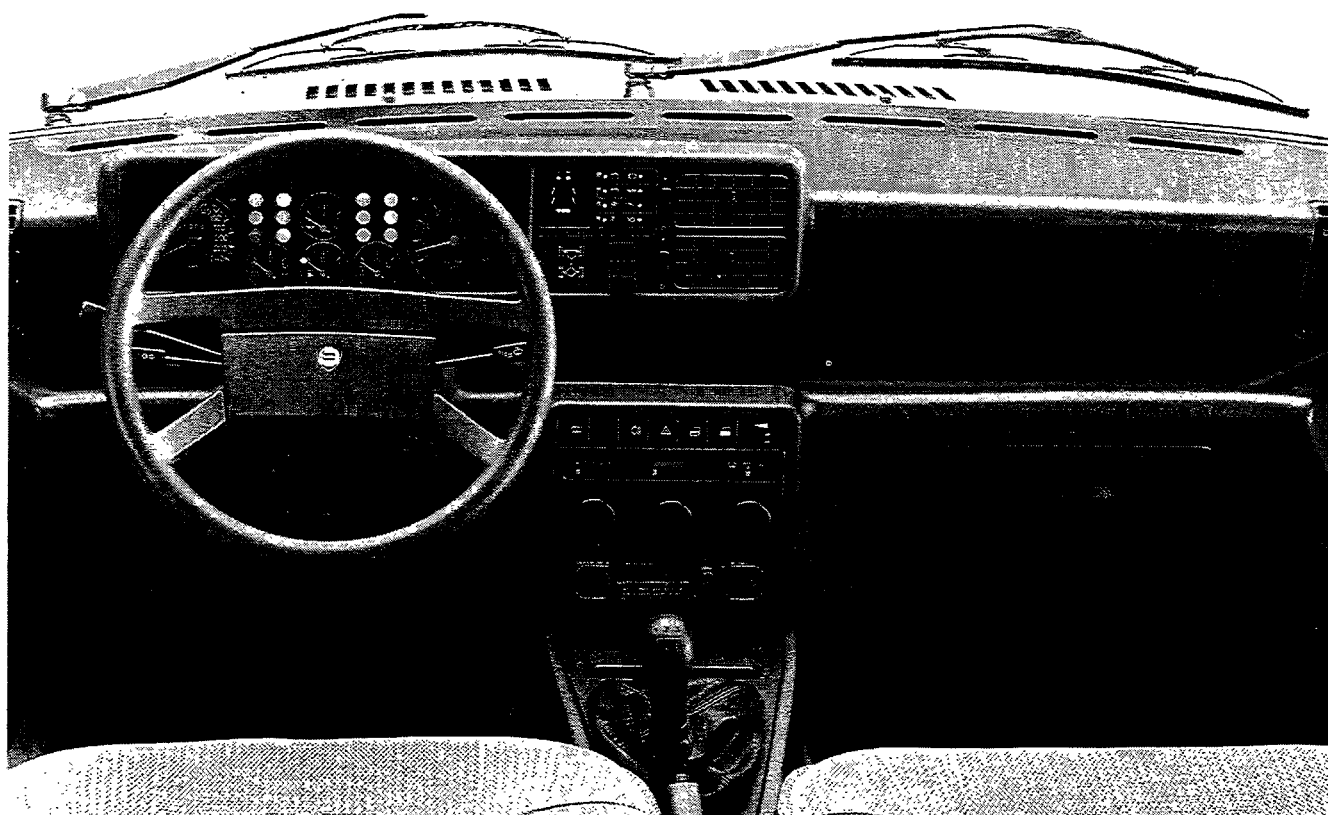

View of the dashboard on the PRISMA 4WD



**View of the interior of the DELTA HF 4WD**

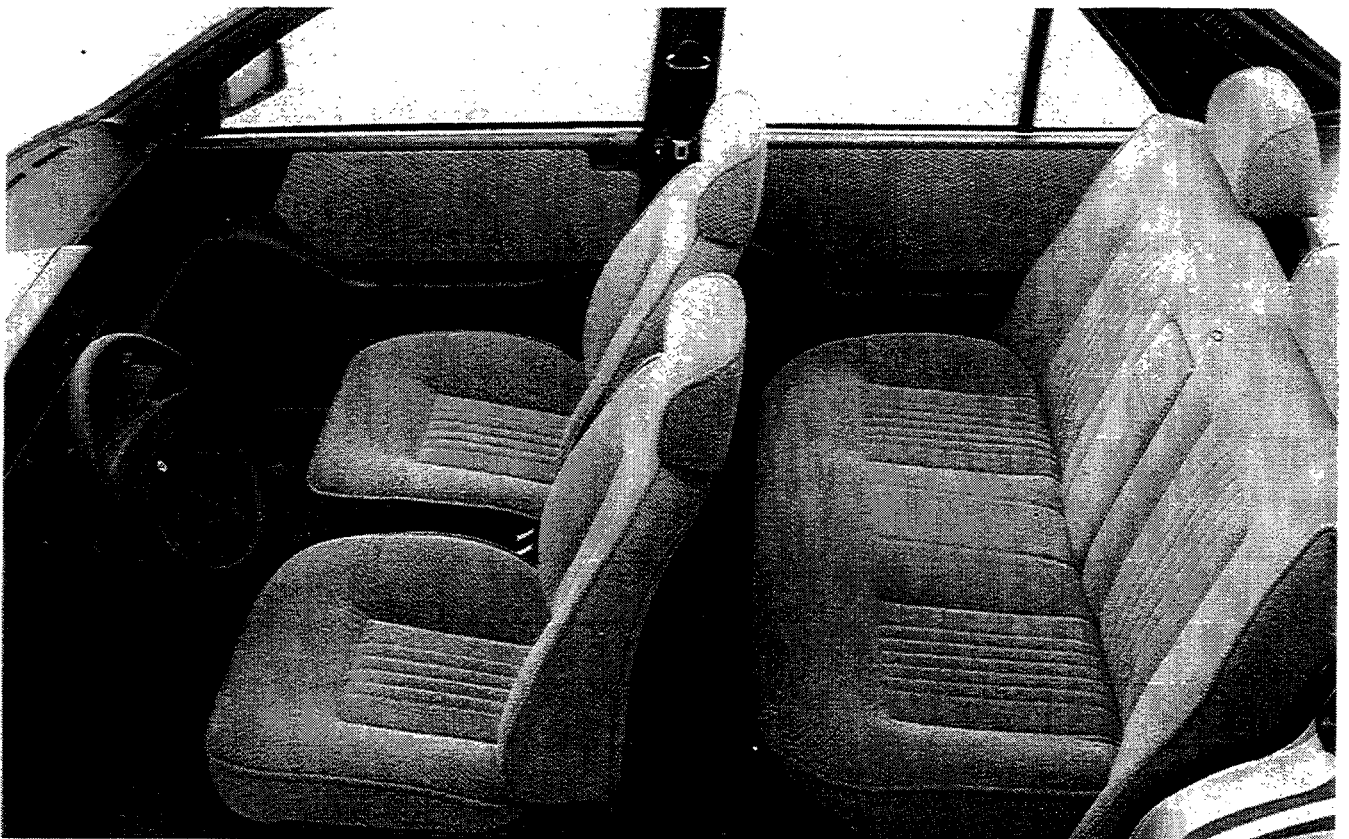

**View of the interior of the PRISMA 4WD**

## 00.0

Instrument panel on the DELTA HF 4WD

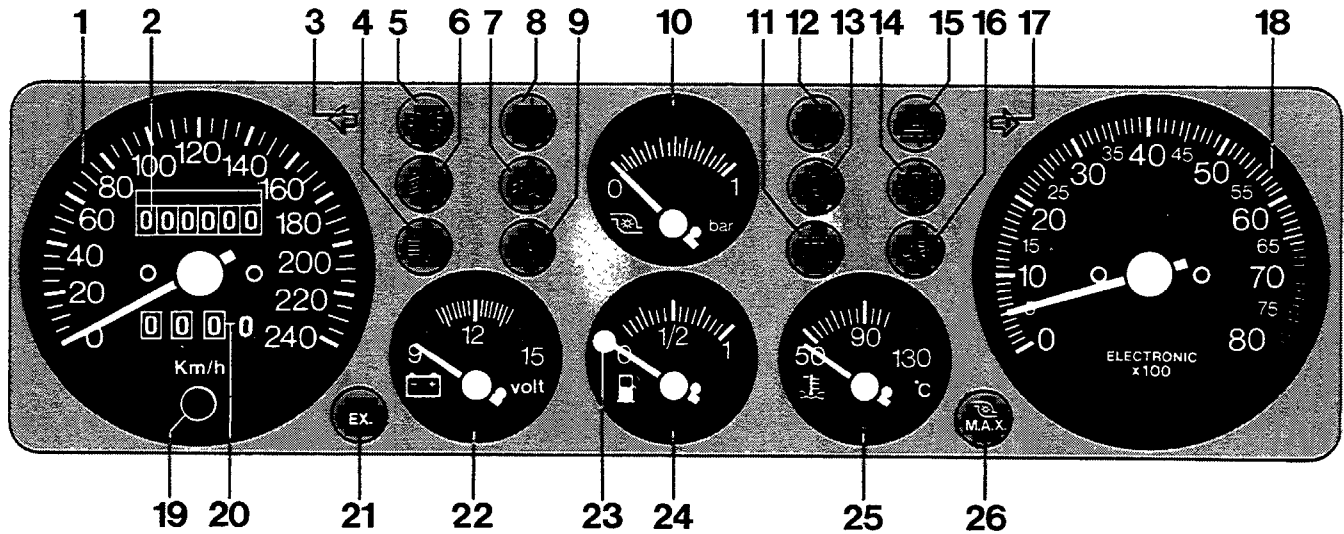

1. Speedometer
2. Milometer
3. Left direction indicator signal
4. Main beam headlamps warning light
5. Dipped headlamps warning light
6. Lights warning lights
7. Fog lamps warning light
8. Starting go ahead signal
9. Rear fog lamps warning light
10. Turbocharger pressure gauge
11. Heated rear windscreen warning light
12. General warning light
13. Handbrake warning light
14. Brake pad wear warning light
15. Hazard warning lights warning light
16. Coolant overheating warning light
17. Right direction indicator signal
18. Rev counter
19. Push button for zeroing trip meter
20. Trip meter
21. Catalytic silencer maximum temperature warning light (for specific markets)
22. Volt meter
23. Fuel reserve warning light
24. Fuel gauge
25. Coolant temperature gauge
26. Overboost engaged warning light



### Instrument panel on the PRISMA 4WD

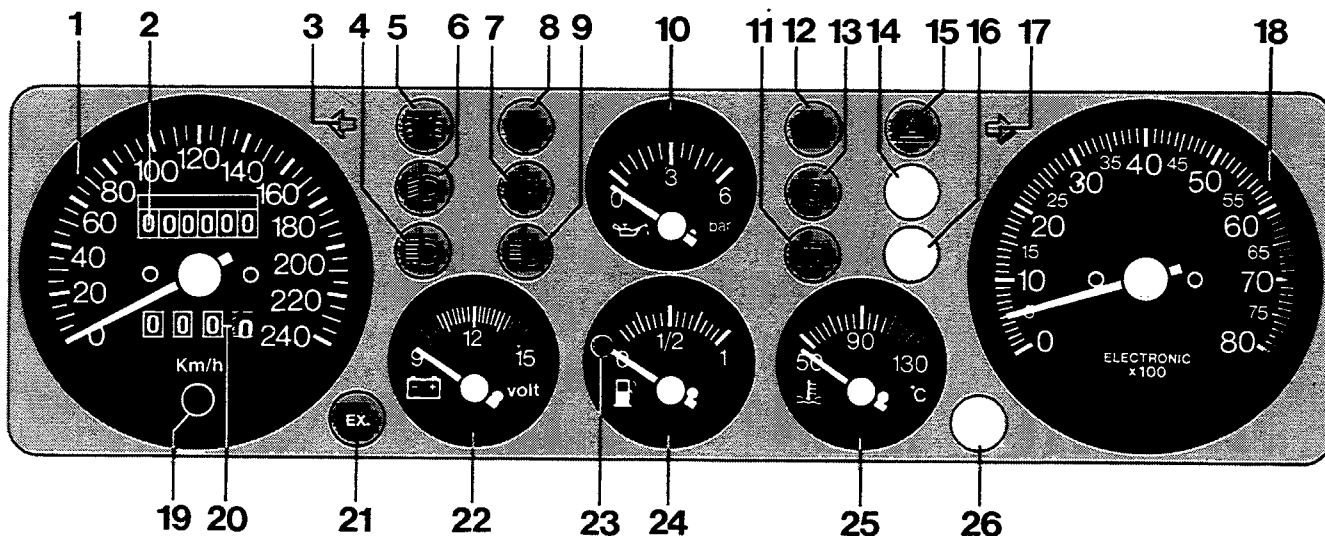

- |  |   |
|--|---|
| <ol style="list-style-type: none"> <li>1. Speedometer</li> <li>2. Milometer</li> <li>3. Left direction indicator signal</li> <li>4. Main beam headlamps warning light</li> <li>5. Lights warning light</li> <li>6. Dipped headlamps warning light</li> <li>7. Rear fog lamps warning light</li> <li>8. General warning light</li> <li>9. Driving lights warning light</li> <li>10. Engine oil pressure gauge</li> <li>11. Heated rear windscreen warning light</li> <li>12. Starting go ahead signal</li> <li>13. Handbrake warning light</li> </ol> | <ol style="list-style-type: none"> <li>14. Spare warning light</li> <li>15. Hazard warning lights warning light</li> <li>16. Spare warning light</li> <li>17. Right direction indicator signal</li> <li>18. Rev counter</li> <li>19. Push button for zeroing trip meter</li> <li>20. Trip meter</li> <li>21. Catalytic silencer maximum temperature warning light (for specific markets)</li> <li>22. Volt meter</li> <li>23. Fuel reserve warning light</li> <li>24. Fuel gauge</li> <li>25. Coolant temperature gauge</li> <li>26. Spare warning light</li> </ol> |
|--|---|

00.0

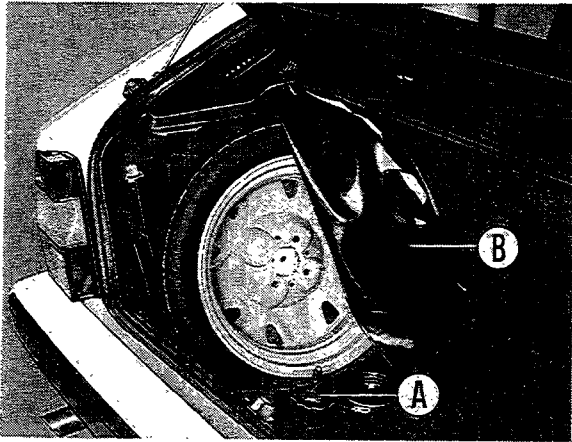

Spare wheel housing on the DELTA HF 4WD

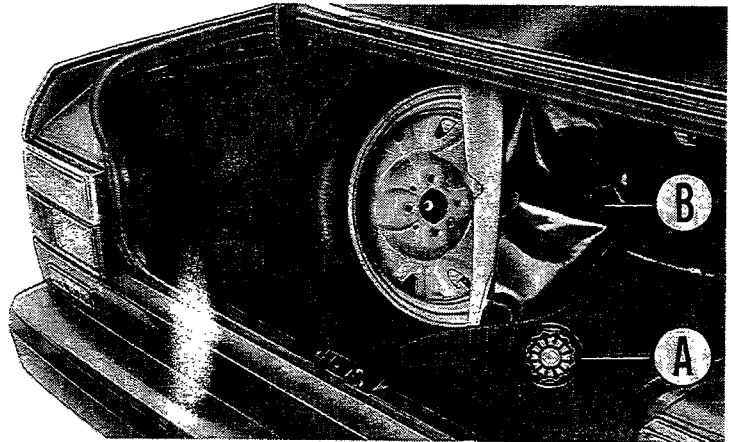

Spare wheel housing on the PRISMA 4WD

**NOTE** *The spare wheel is smaller; in order to remove it from its housing undo the clip A and remove the cover B. This wheel should only be used for essential journeys to reach a garage where repairs can be carried out. Maximum speed 80 kph (50 mph).*

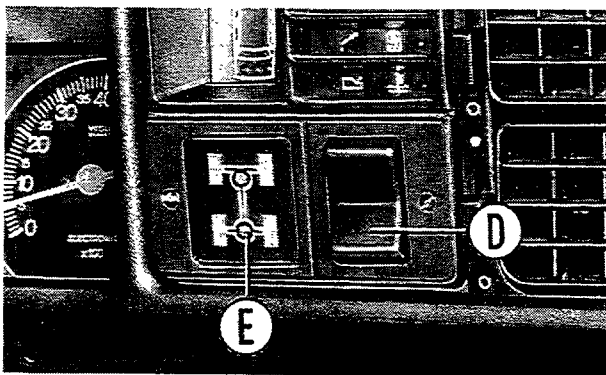

Engaging-releasing rear differential for the PRISMA 4WD

In order to lock the rear differential press the lower section of switch D and LED E should come on. To release the differential press the upper section of switch D

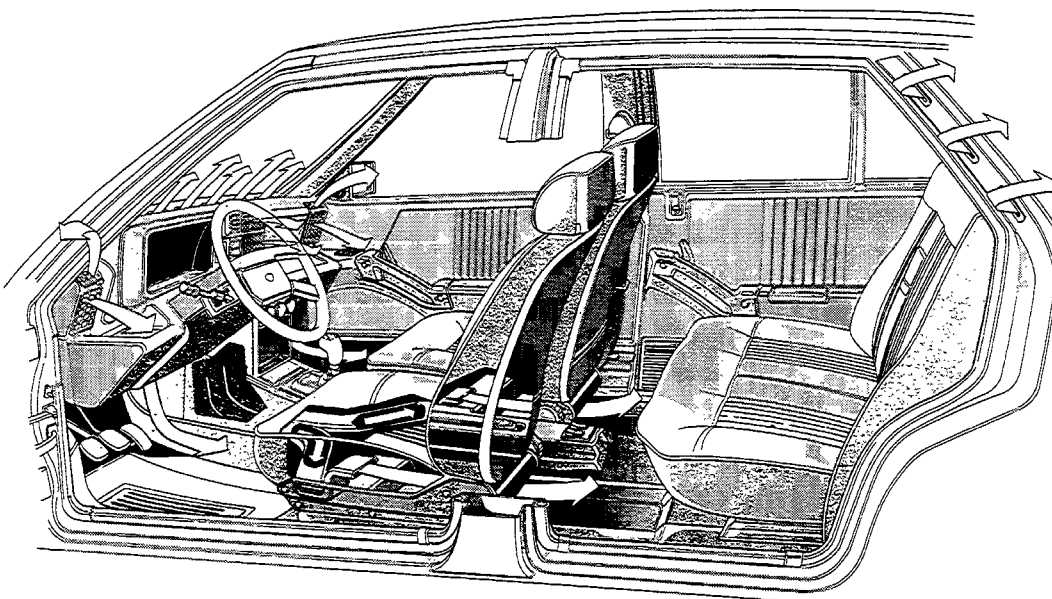

Diagram showing passenger compartment ventilation on the PRISMA 4WD

# Introduction

## Dimensions

# DELTA-PRISMA 4WD

### 00.0

#### DELTA HF 4WD

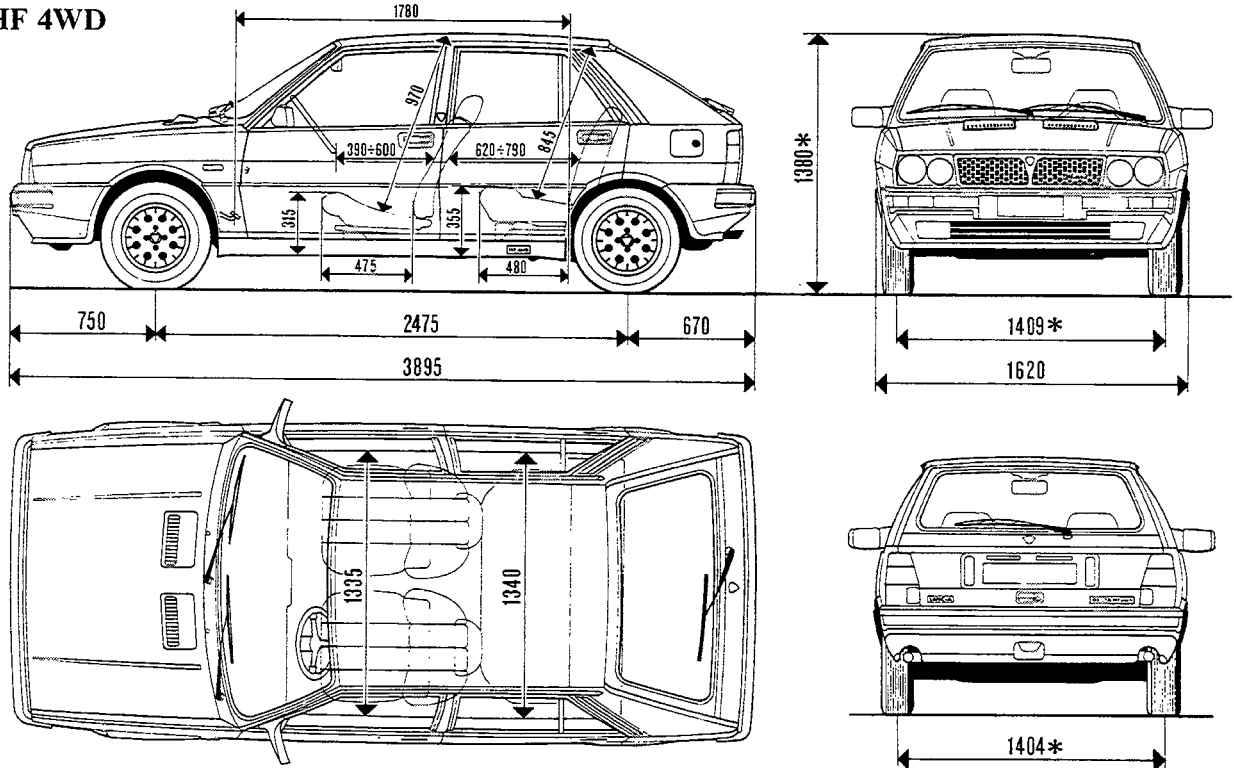

(\*) Unladen vehicle

Luggage compartment capacity with the rear seat backrest in its normal position: 200 litres (7.06 cu ft).

Luggage compartment capacity with the rear seat folded down : 940 litres (33.19 cu ft)

#### PRISMA 4WD

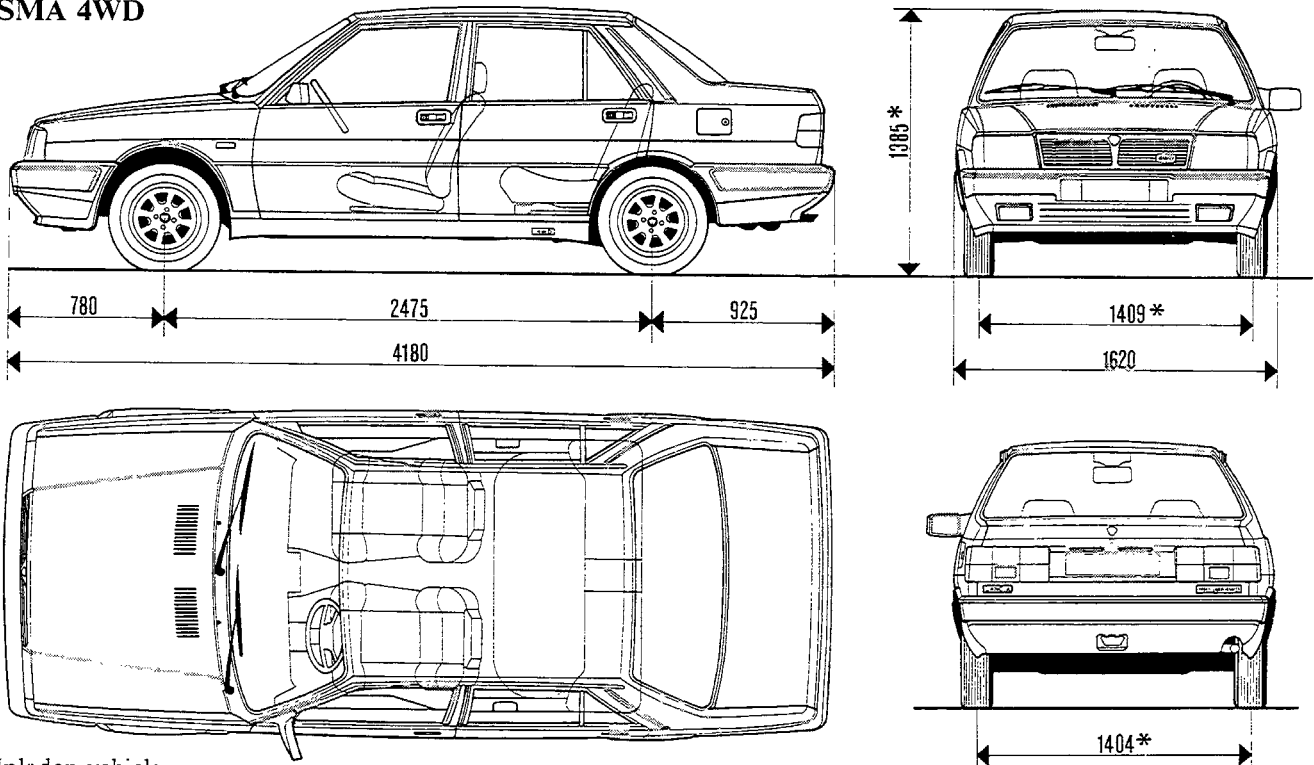











(\*) Unladen vehicle

Luggage compartment capacity with rear seat backrest in upright position: 360 litres (12.71 cu ft).

Luggage compartment capacity with rear seat folded down to level of rear parcel shelf: 650 litres (22.95 cu ft).

00.0

WEIGHTS (in kg)

		
	1190	1180
+ 450  	1640	1630
 +   	865	855
Kerb weight 	775	775
	1200	

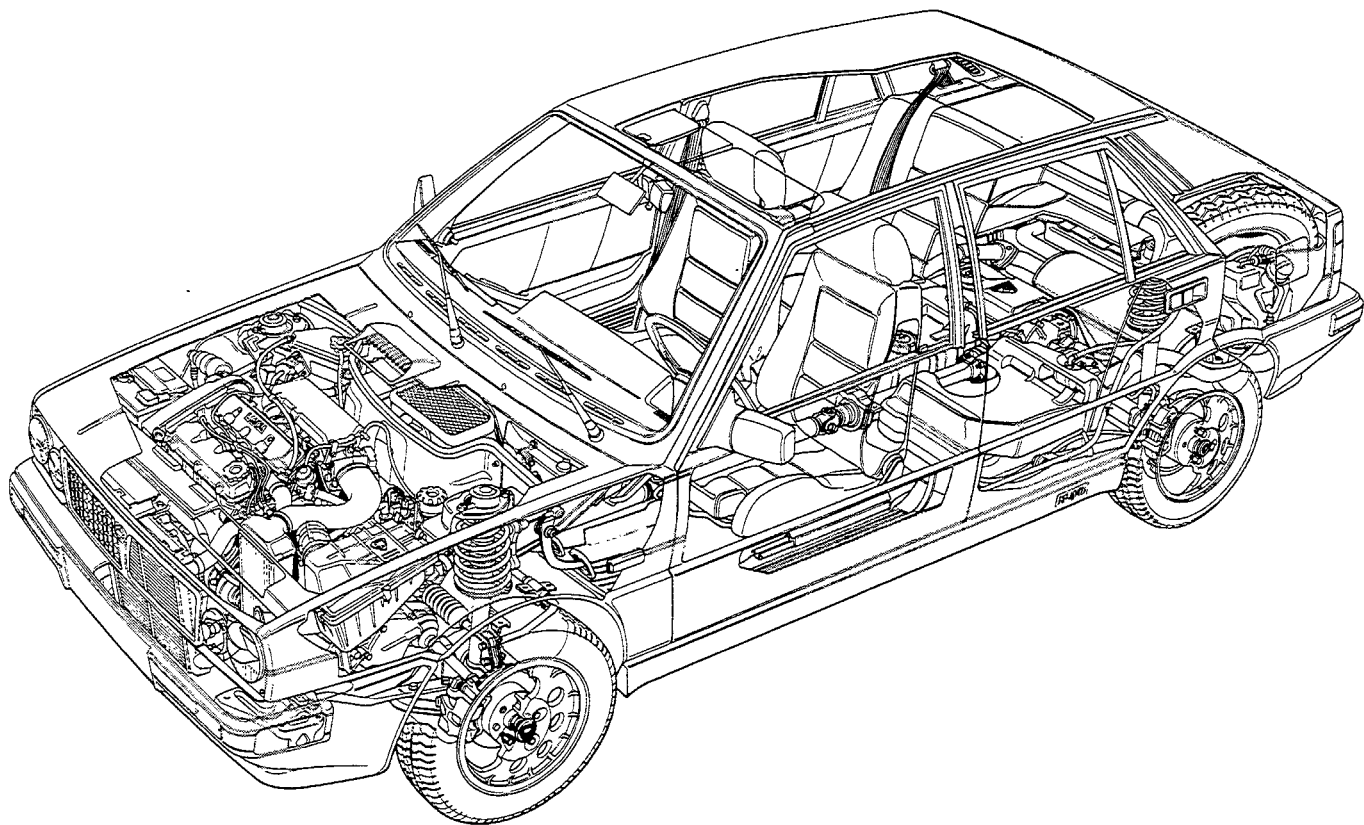

















Arrangement of mechanical components in the DELTA HF 4WD

# Introduction

## Performance - Fuel consumption

# DELTA-PRISMA 4WD

00.0

			
<p>Speed in kph</p> 		65	55
		105	90
		155	130
		200	170
		208	184
		65	55
<p>Maximum climable gradient</p> 		58	42
		37	23
		23	15
		16	10
		11	7
		68	40
<p>EEC fuel consumption figures (litres/100 km) (mpg)</p> 	Urban cycle (A)	10,8 (26.15)	11 (25.68)
	Constant speed 90 kph (B)	7,8 (36.21)	7,8
	Constant speed 120 kph (C)	10,2 (27.69)	10 (28.24)
	Average consumption (CCMC proposal) $\frac{A + B + C}{3}$	9,6 (29.42)	9,6

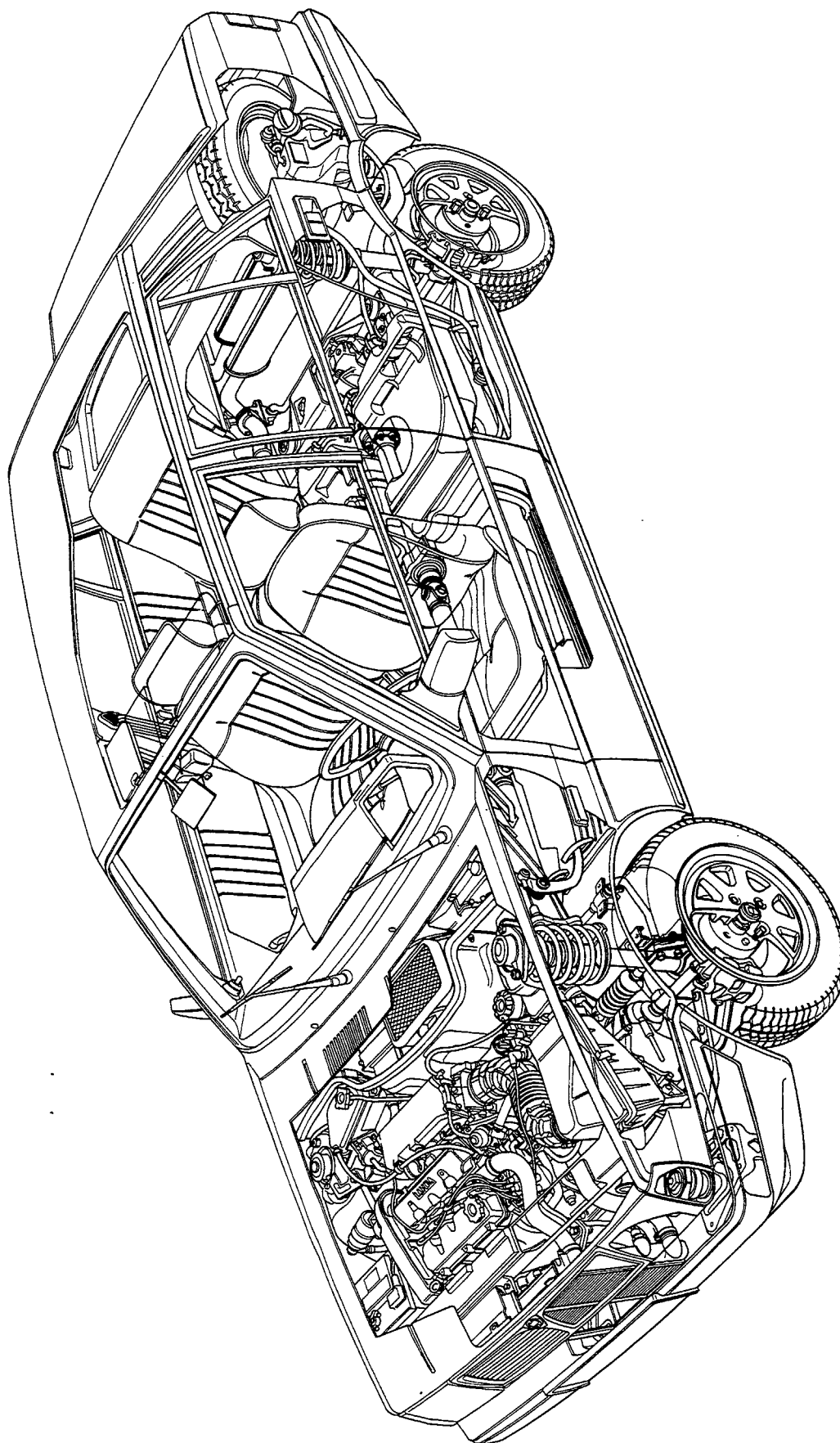

















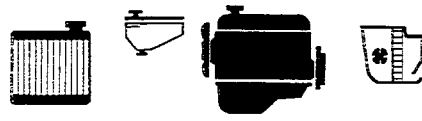









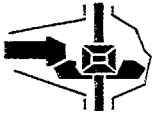



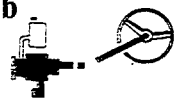

Arrangement of mechanical components on the PRISMA 4WD

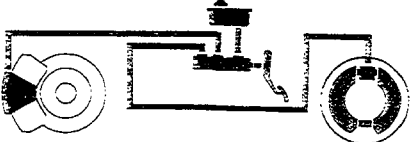
# Introduction

## Capacities

# DELTA-PRISMA 4WD



00.0

Description	Unit		Quantity	
			dm <sup>3</sup>	(kg)
 Petrol O.R. (98-100)	 	57	-	
50%  H <sub>2</sub> O +  Parafin FIAT 11  	 Total capacity of cooling system	6	-	
 VS- Superstagionale (SAE 10 W) (SAE 20 W) (SAE 30) (SAE 40)	Total capacity 	-	5,20	
VS- Supermultigrade (SAE 15 W/40)		-	4,80	
VS- Turbo Synthesis (SAE 15 W/40)	Partial capacity (periodic replacment)	-	4,80	
 a = TUTELA ZC 80S  b = TUTELA GI/A 		a	-	3,40
		b	-	-
 TUTELA W 90/M DA	a  b  Self-locking	a	-	-
		b	-	1
 a e b = TUTELA GI/A	a  c  d 	a	-	0,61
 c = TUTELA W 90/M-DA	b 	b	-	-
d = K 854		c	-	-
		d	-	-
 TUTELA DOT 4	Total capacity 	-	0,30	
 H <sub>2</sub> O	 3%	 PRISMA 4WD	2,50	-
	 ~ -10°C 50%	 DELTA 4WD	2	-
	 ~ -20°C 100%			



▲ Distilled water

Name of product	Description International designation	Usage
VS+ Supersta- gionale	SAE 40	Temperature 0°C ÷ >35°C
	SAE 30	Temperature 0°C ÷ <35°C
	SAE 20 W	Minimum temperature - 15°C ÷ 0°C
	SAE 10 W	Minimum temperature below - 15°C
VS- Super- multigrade	SAE 15 W/40 Low ash content detergent oil for petrol engines. Service API "SE". Satisfies standard MIL-L-46152. Exceeds European CCMC specifications	Temperature - 15°C ÷ >35°C
VS Turbo Synthesis SAE 15 W/40	Synthetic based detergent oil for petrol engines. Service API "SE". Satisfies standard MIL-L-46152. Exceeds European CCMC specifications.	Temperature - 15°C ÷ >40°C
VS Diesel	SAE 40	Temperature 0°C ÷ 50°C
	SAE 30	Temperature - 5°C ÷ 30°C
	SAE 20 W	Temperature - 15°C ÷ 15°C
	SAE 10 W	Temperature below - 15°C
VS Diesel Supermultigrade	Oil for Diesel engines. Service API "CD". Satisfies standard MIL-L-2104 C	Temperature - 20°C ÷ 40°C
TUTELA ZC 80S	SAE 80/W oil. Satisfies standard MIL-L-2105 API GL4	Manual gearboxes and differentials
TUTELA ZC 90	Non EP SAE 80 W/90 oil for manual gearboxes, containing anti-wear additives.	Gearboxes and non hypoid differentials
TUTELA W 90/M DA	EP SAE 80 W/90 oil for normal and self-locking differentials. Satisfies standard MIL-L-2105 C.	Hypoid differentials Self-locking diffs. Steering boxes
TUTELA GI/A	DEXRON II type oil for automatic transmissions.	Automatic gearboxes Power assisted steering
TUTELA JOTA 1	Lithium soap based grease, N.L.G.I.N.1 consistency	Greasing vehicle except for components particu- larly exposed to water requiring special greases
TUTELA MRM2	Lithium soap based molybdenum disulphide water repellent grease, N.L.G.I.N.2 consistency	Constant velocity joints
TUTELA MR3	Lithium soap based grease, N.L.G.I.N.3 consistency	Wheel hub bearings, steering rods, various components
TUTELA DOT 4	DOT 4 hydraulic brake fluid, meeting F.M.V.S.S. standard no. 116	Hydraulic brakes and hy- draulically operated clutch
K 854	Lithium soap based grease, N.L.G.I. 000 consistency, containing molybdenum disulphide	Rack and pinion steering boxes
SP 349	Special castor oil and sodium based grease containing graphite and molybdenum disulphide, compatible with brake fluid and rubber circuit seals	Load proportioning valve Load proportioning valve control bar bush
Liquido Autofà DP1	Alcohol based liquid detergent	To be used undiluted or dilu- ted for windscreen washers and headlamps washers
Liquido Paraflu <sup>11</sup> FIAT	Mono ethylene glycol based anti-freeze for cooling system	Cooling circuits Percentage to be used 35% up to - 25°C 50% up to - 35°C

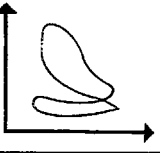

	
--	---

### CHARACTERISTICS

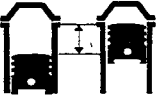
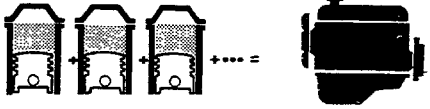
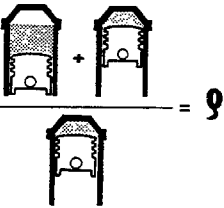
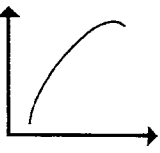
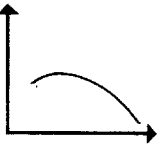
		831 B5.000	831 B4.000	
	Cycle	OTTO 4 stroke		
	Number of cylinders	4		
	Cylinder liner (bore)	mm	84	
	Stroke	mm	90	
	Capacity	cc	1995	
	Compression ratio		$8 \pm 0,1$ $9,75 \pm 0,15$	
	Max power EEC	kW (CV)	122 (165)	84,5 (115)
		rpm	5250	5400
	Max torque EEC	daNm (kgm)	25,5    28,5 <sup>▲</sup> (26)    (29)	16,3 (16,6)
		rpm	2500 2750 <sup>▲</sup>	3250

(▲) With overboost engaged

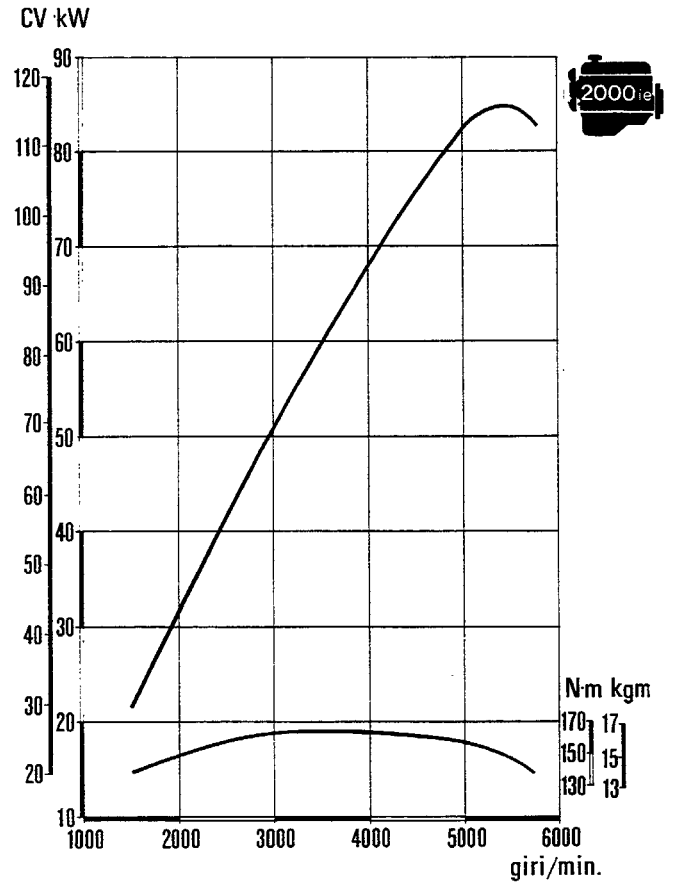
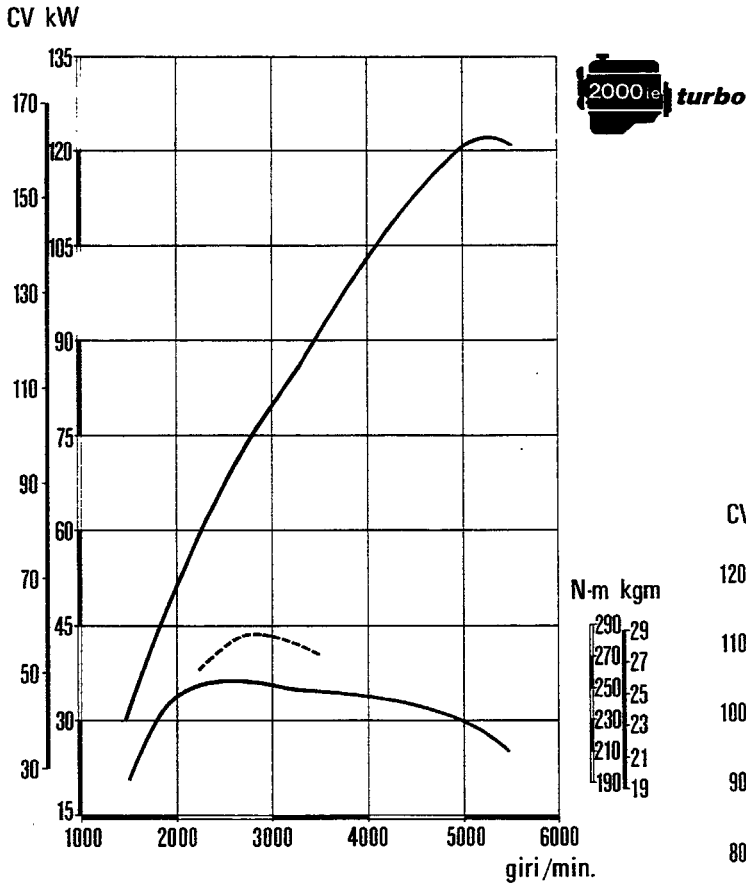

### Characteristic power curves from EEC method

The power curves shown can be obtained with the engine overhauled and run in without a fan and with a silencer and air filter fitted at sea level.

### Test bench test cycle with overhauled engine

In the bench test of the overhauled engine it is not advisable to run the engine at maximum speed but to stick to the figures given in the table; complete the running in of the actual engine in the car.

Test speed (rpm)	Time in minutes	Load on the brakes
800 ÷ 1000	10'	no load
1500	10'	no load
2000	10'	no load

# Technical data

# DELTA-PRISMA 4WD

## Engine: cylinder block/crankcase, crankshaft and associated components

00.10

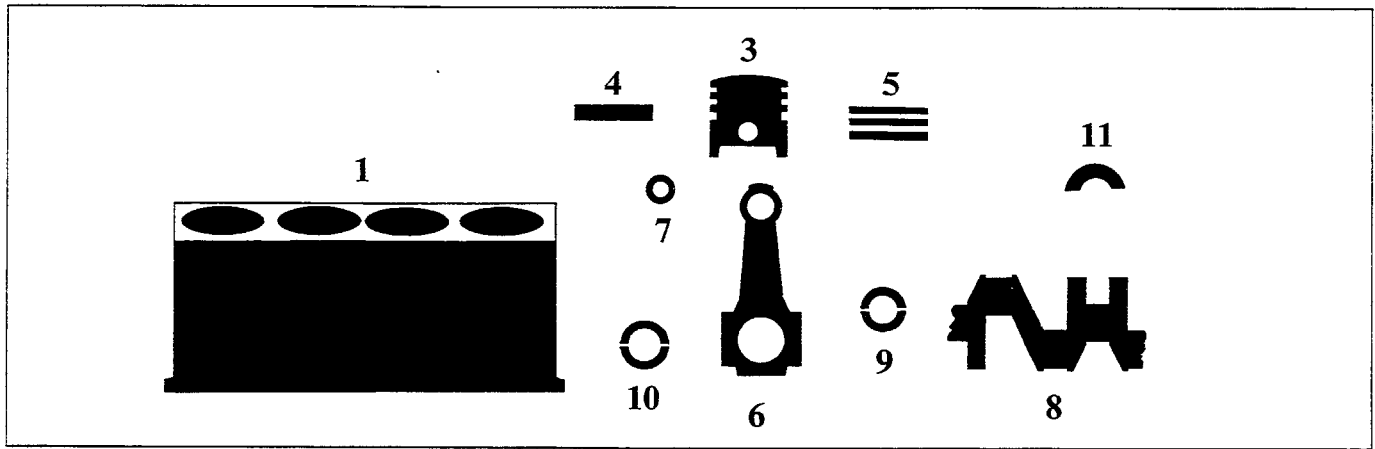

--	--

### DESCRIPTION









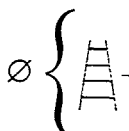

		Values in mm	
<p>1 Main bearing supports</p>	L		23,100 ÷ 23,200
	$\left. \begin{array}{l} A \\ B \\ C \end{array} \right\} \varnothing$	A	56,717 ÷ 56,723
		B	56,723 ÷ 56,729
		C	56,729 ÷ 56,735
<p>Cylinder bore</p>	$\varnothing \left( \begin{array}{l} A \\ B \\ C \end{array} 0,010 \right)$		84,000 ÷ 84,050
<p>3 Piston</p>	Y		25
	$\left. \begin{array}{l} A \\ C \\ E \end{array} \right\} \varnothing$	A	83,940 ÷ 83,950
		C	83,960 ÷ 83,970
		E	83,980 ÷ 83,990
	$\varnothing \text{ LANCIA } >$		0,4
<p>3 Difference in weight between pistons</p>			± 5 g
<p>3-1 Piston-Cylinder bore</p>			0,050 ÷ 0,070
<p>3 Gudgeon pin housing</p>	$\left. \begin{array}{l} 1 \\ 2 \end{array} \right\} \varnothing$	1	21,996 ÷ 21,999
		2	21,999 ÷ 22,002

# DELTA-PRISMA 4WD

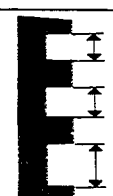
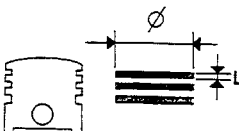
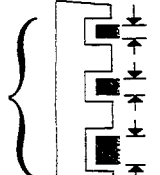
## Engine: cylinder block/crankcase, crankshaft and associated components

### Technical data

00.10

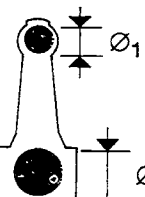
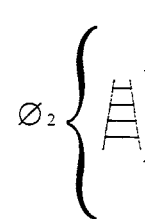
				
DESCRIPTION		Values in mm		
4		$\varnothing$ 	1	21,991 ÷ 21,994
			2	21,994 ÷ 21,997
	Gudgeon pin	$\varnothing$ LANCIA >	0,2	
4-3		Gudgeon pin-Housing	0,002 ÷ 0,008	
3			1	1,535 ÷ 1,555
			2	2,030 ÷ 2,050
			3	3,967 ÷ 3,987
5		$L$ 	1	1,478 ÷ 1,490
			2	1,978 ÷ 1,990
			3	3,925 ÷ 3,937
	Piston rings	$\varnothing$ LANCIA >	0,4	
5-3			1	0,045 ÷ 0,077
			2	0,040 ÷ 0,072
			3	0,030 ÷ 0,062
5-1	 		1	0,30 ÷ 0,45
			2	0,30 ÷ 0,45
			3	0,25 ÷ 0,40
6		$\varnothing_1$ 		24,988 ÷ 25,021
			1	53,904 ÷ 53,910
			2	53,898 ÷ 53,904
	Big end bearing housing	$\varnothing_2$	3	53,892 ÷ 53,898

# Technical data

# DELTA-PRISMA 4WD

## Engine: cylinder block/crankcase, crankshaft and associated components

00.10

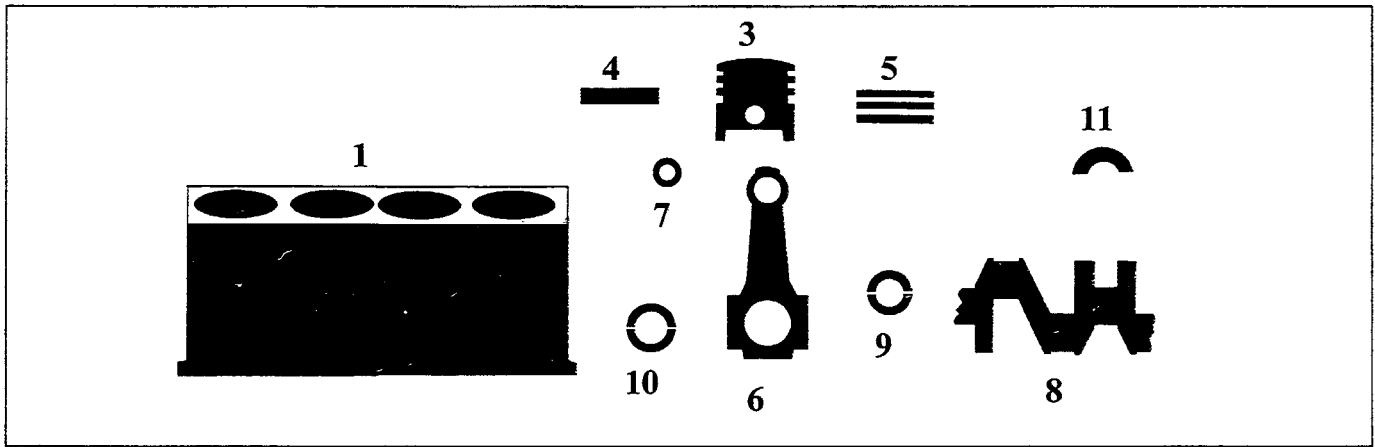

### DESCRIPTION

Values in mm

<p>7</p> <p>Small end bush</p>	$\varnothing_1$		25,065 ÷ 25,090	
		$\varnothing_2$	1	22,004 ÷ 22,007
	2		22,007 ÷ 22,010	
<p>4-7</p> <p>Gudgeon pin Small end bush</p>			0,010 ÷ 0,016	
<p>7-6</p> <p>Small end bush Housing</p>			0,044 ÷ 0,102	
<p>8</p> <p>Main journals</p>	$\varnothing_1$	A	52,998 ÷ 53,004	
		B	52,992 ÷ 52,998	
		C	52,986 ÷ 52,992	
<p>Crank pins</p>	$\varnothing_2$	1	50,799 ÷ 50,805	
		2	50,793 ÷ 50,799	
		3	50,787 ÷ 50,793	
	L	27,975 ÷ 28,025		
<p>9</p> <p>Crankshaft bearings</p>	L	A	1,838 ÷ 1,844	1,836 ÷ 1,842
		B	1,844 ÷ 1,850	1,842 ÷ 1,848
		C	1,850 ÷ 1,856	1,848 ÷ 1,854
$\varnothing$ LANCIA <			0,254 – 0,508	







			
DESCRIPTION		Values in mm	
9-8	 Crankshaft bearings-Main journals	0,025 ÷ 0,049	0,029 ÷ 0,053
10	 <p>Big end bearings</p> <p>L {</p> <p>A</p> <p>B</p> <p>C</p> <p>Ø LANCIA &lt;</p>	1,527 ÷ 1,533	
		1,533 ÷ 1,539	
		1,539 ÷ 1,545	
		0,254 - 0,508	
10-8	 Big end bearings-Pins	0,033 - 0,057	
11	 <p>Thrust washers</p> <p>S</p> <p>S LANCIA &gt;</p>	2,310 ÷ 2,360	
		0,127	
11-8	 Crankshaft end float	0,055 - 0,305	

Diagram showing connecting rod-piston assembly and direction of rotation in engine

A = Area where number of cylinder bore to which connecting rod belongs is stamped.

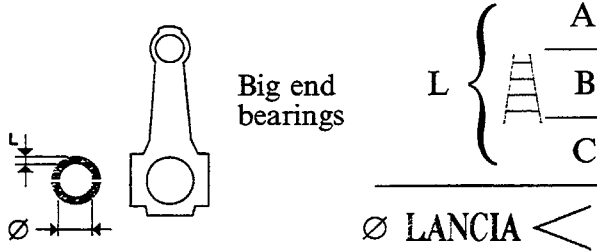
The arrow shows the direction of rotation of the engine as seen from the timing side.

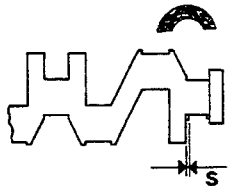
1mm = Gudgeon pin offset on the piston.

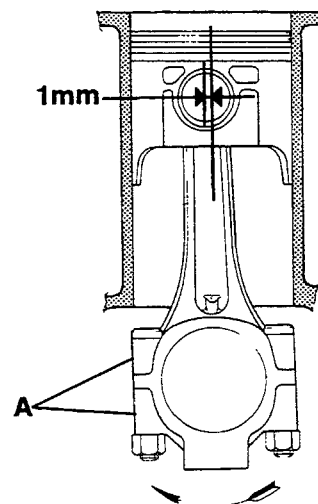

00.10

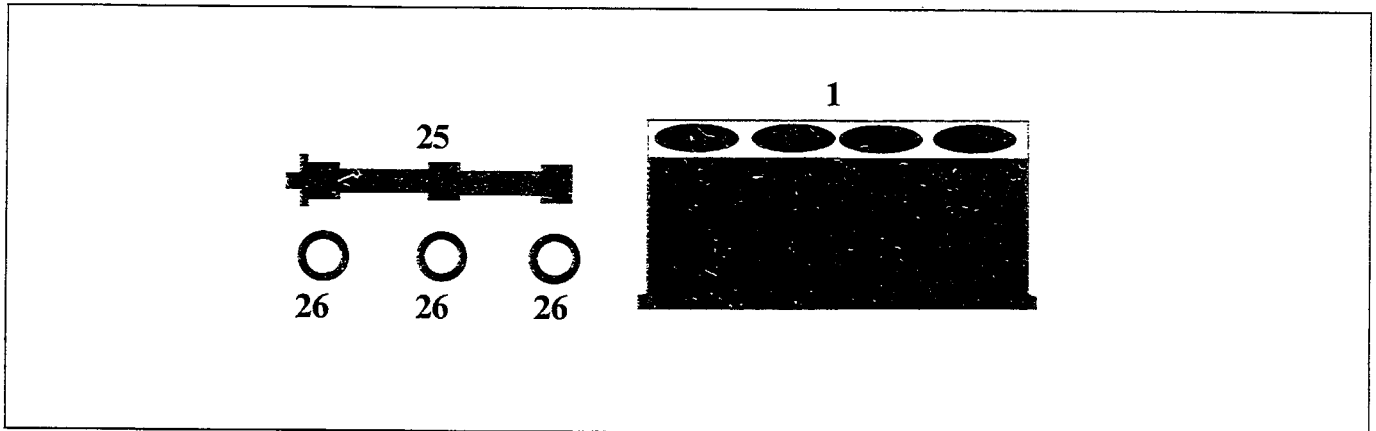



**DESCRIPTION**

Values in mm

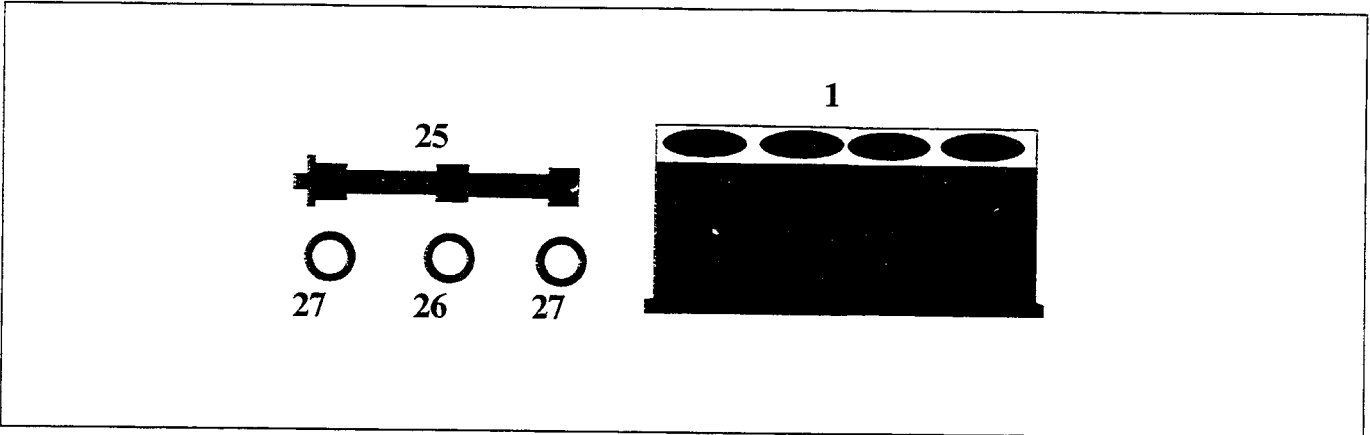
<b>25</b>	Counter-balance shafts		n° 2
	Shafts operated		by toothed belt
<b>26</b>		Ø <sub>1</sub>	36,920 ÷ 36,940
		Ø <sub>2</sub>	37,020 ÷ 37,040
		Ø <sub>3</sub>	38,020 ÷ 38,040
	Bushes for counter-balance shafts in housings		
<b>25</b>		Ø <sub>1</sub>	36,850 ÷ 36,870
		Ø <sub>2</sub>	36,950 ÷ 36,970
		Ø <sub>3</sub>	37,950 ÷ 37,970
<b>26-1</b>	Bushes for shaft Housings		0,080 ÷ 0,140
<b>25-26</b>	Shaft bearings - Bushes		0,050 ÷ 0,090

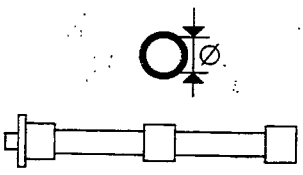
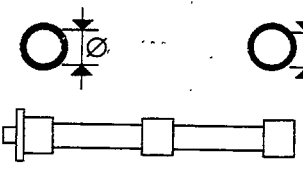
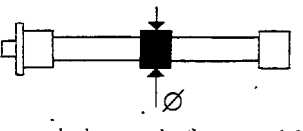
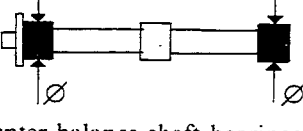

DESCRIPTION

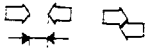
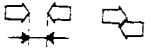
		Values in mm
<b>25</b>	Counter-balance shafts	n° 2
Shafts operated		by toothed belt
<b>26</b>	 Central bush for counter-balance shafts in housing	$\emptyset$ 37,020 ÷ 37,040
<b>27</b>	 Ball bearings for counter-balance shafts	$\emptyset$ 19,990 ÷ 20,000
<b>25</b>	 Counter-balance shaft central bearing	$\emptyset$ 36,945 ÷ 36,960
<b>25</b>	 Counter-balance shaft bearings	$\emptyset$ 19,980 ÷ 19,993
<b>26-1</b>	 Bushes for shaft Housings	0,080 ÷ 0,140
<b>25-26</b>	 Shaft bearings - Bushes	0,060 ÷ 0,095
<b>27-1</b>	 Ball bearings Housings	+0,011 ÷ -0,025
<b>25-27</b>	 Shaft bearings Ball bearings	+0,020 ÷ -0,003





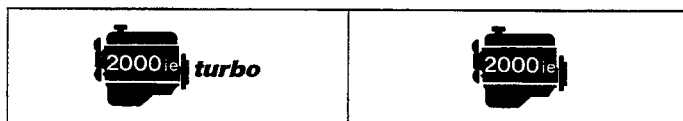
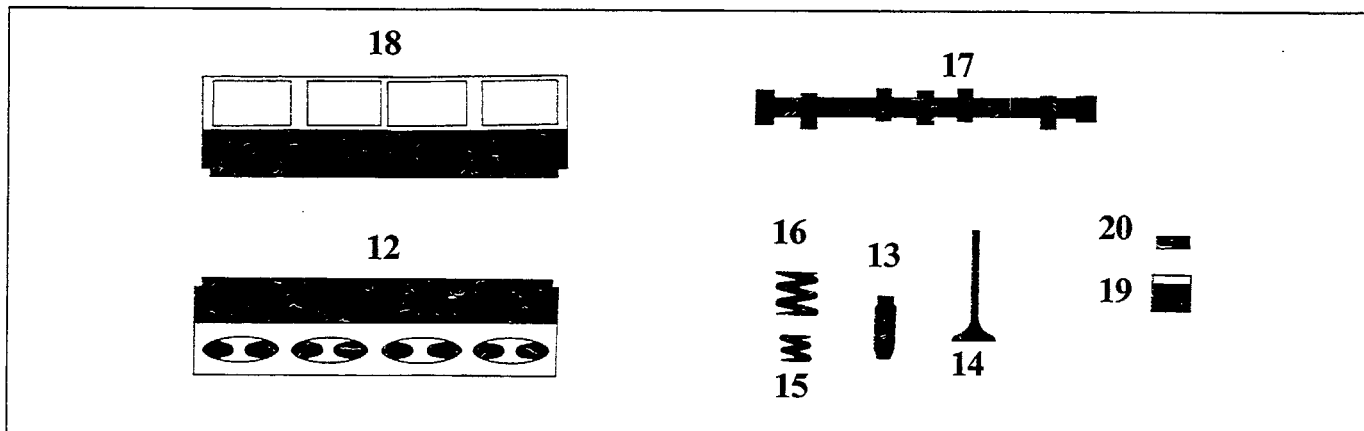





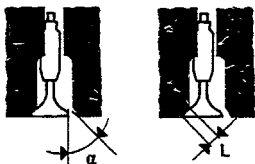

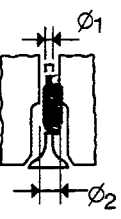







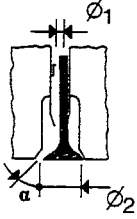

00.10

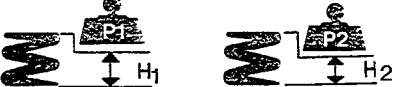
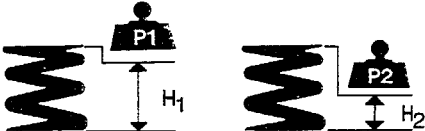
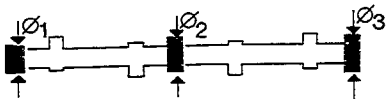
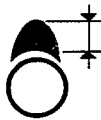

### DESCRIPTION

Values in mm

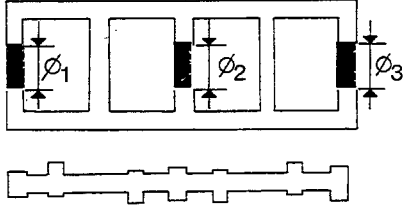
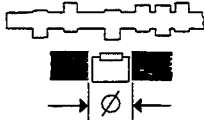
12		Valve guide bore in cylinder head	$\emptyset$	13,950 ÷ 13,977		
			Valve seats	$\alpha$ 	45° ± 5'	
$\alpha$ 	45° ± 5'					
13		Valve guide	$\emptyset_1$ 	8,022 ÷ 8,040		
			$\emptyset_2$ 		14,040 ÷ 14,058	
					13,988 ÷ 14,016	14,040 ÷ 14,058
			$\emptyset_2$ LANCIA 	0,05-0,10-0,25		
13-12		Valve guide Bore in cylinder head		0,063 ÷ 0,108		
				0,021 ÷ 0,066	0,063 ÷ 0,108	
14		Valves		$\emptyset_1$	7,974 ÷ 7,992	
				$\emptyset_2$	43,300 ÷ 43,700	
				$\alpha$	45° 30' ± 5'	
				$\emptyset_1$	7,974 ÷ 7,992	
				$\emptyset_2$	35,850 ÷ 36,450	
				$\alpha$	45° 30' ± 5'	

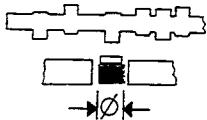
				
DESCRIPTION		Values in mm		
14-13	 Valve-Valve guide	0,030 ÷ 0,066		
15	 Internal valve spring	P <sub>1</sub>	14,13 ÷ 15,11 daN	
		H <sub>1</sub>	31	
		P <sub>2</sub>	26,39 ÷ 28,74 daN	
		H <sub>2</sub>	21,5	
16	 External valve spring	P <sub>1</sub>	36,68 ÷ 39,6 daN	
		H <sub>1</sub>	36	
		P <sub>2</sub>	55,91 ÷ 60,82 daN	
		H <sub>2</sub>	26,5	
17	 Camshaft bearings	∅ <sub>1</sub>	29,944 ÷ 29,960	
		∅ <sub>2</sub>	45,755 ÷ 45,771	
		∅ <sub>3</sub>	46,155 ÷ 46,171	
	 Cam lift		9,1	10,033
			8,6	10,033
18	 Camshaft bearings in camshaft housing	∅ <sub>1</sub>	30,009 ÷ 30,034	
		∅ <sub>2</sub>	45,800 ÷ 45,825	
		∅ <sub>3</sub>	46,200 ÷ 46,225	
17-18	 Tappet housings	∅	37,000 ÷ 37,025	
		 Camshaft bearings housing	∅ <sub>1</sub>	0,049 ÷ 0,090
			∅ <sub>2</sub> - ∅ <sub>3</sub>	0,029 ÷ 0,070
19	 Tappet	∅	36,975 ÷ 36,995	

# Technical data

# DELTA-PRISMA 4WD

## Engine: cylinder head and valve gear components

00.10

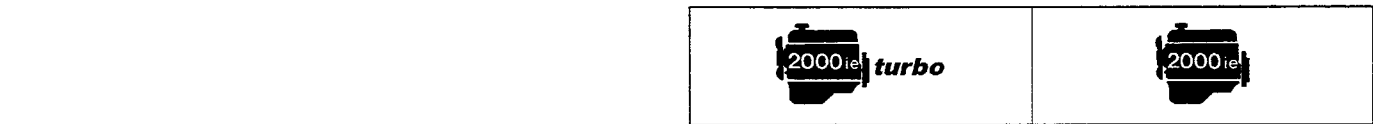
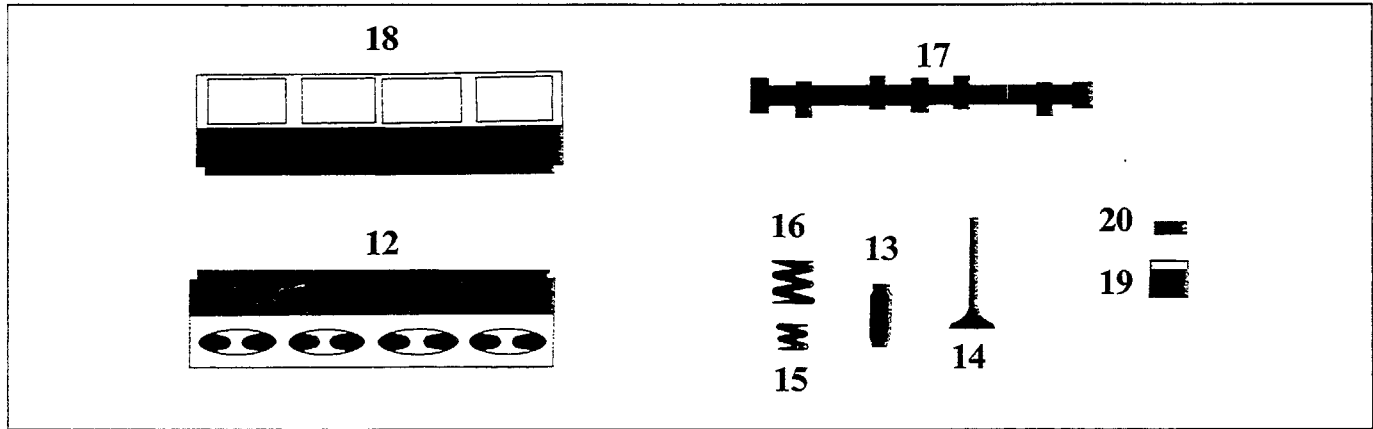







### DESCRIPTION

			Values in mm			
19-18		Tappet Housing in cylinder head	0,005 ÷ 0,050			
20		S (  0,05 ) Shim	3,25 ÷ 4,70			
17-20		Clearance for timing check		0,80		
				0,80		
		operational-clearance		0,35 ± 0,04	0,40 ± 0,04	
				0,40 ± 0,04	0,48 ± 0,03	

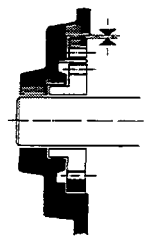
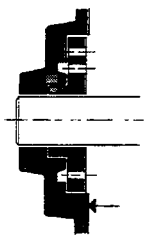
### TIMING ANGLES

inlet	opens BTDC	8°	7°
	closes ABDC	42°	52°
exhaust	opens BBDC	42°	53°
	closes ATDC	1°	6°

		
	Values in mm	
Oil pump	lobe gears	
Pump operated	by crankshaft	
Oil pressure relief valve	incorporated in crankshaft front cover	
 <p>between pump casing housing and driven gear</p>	0,080 ÷ 0,186	
 <p>between upper side of gears and pump cover</p>	0,025 ÷ 0,056	
Full flow filter	cartridge	
Insufficient oil pressure sender unit	electrical	
   <p>Operating pressure at a temperature of 100°C</p>	3,4 ÷ 4,9 bar (3,5 ÷ 5 kg/cm <sup>2</sup> )	
 <p>Oil pressure relief valve spring</p>	P <sub>1</sub>	11,3 ÷ 12,1 daN
	H <sub>1</sub>	35,3







# Technical data

# DELTA-PRISMA 4WD

Engine: cooling system-fuel system-supercharging

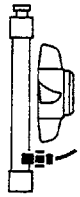
00.10

## COOLING SYSTEM

			
Cooling circuit		coolant circulation via centrifugal pump, radiator and electric fan operated by thermostatic switch	
Water pump operation		through belt	
 Thermal switch to engage fan		90° ÷ 94°C	
		85° ÷ 89°C	
Engine cooling water thermostat	opens	81° ÷ 85°C	
	max opening	97°C	
	valve travel	≥ 7,5 mm	
Clearance between impeller blades and pump casing		0,8 – 1 mm	
Pressure for checking water tightness of system		0,98 bar	
Pressure for checking overflow valve on expansion tank		0,98 bar	

## FUEL SYSTEM

Pump	electric
Capacity	~ 120 litres/h





## SUPERCHARGING (with turbocharger operated by exhaust gases with wastegate valve)

Turbocharger type:	KKK K26	Garrett T3	–
Maximum supercharging pressure	0,9 bar		–

## Checking engine idle speed and carbon monoxide emissions

Engine speed	rpm	800 ÷ 900	(750 ÷ 800)*
CO idle emissions	(%)	1,5 ± 0,5	

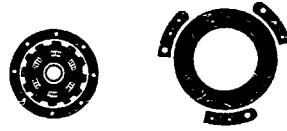
(\*) With VAE valve disconnected

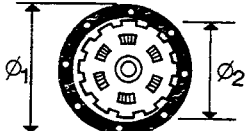
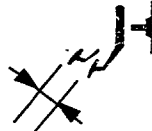
			
		Values in mm	
Type		 dry, single plate	
 Operating mechanism		 diaphragm spring	
Spring loading		575 daN	
 Lining	$\varnothing_1$	230	
	$\varnothing_2$	155	
 Clutch pedal setting		8 ÷ 10 mm below the level of the brake pedal	
Clutch release		mechanical	











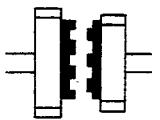

# Technical data

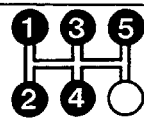
## Gearbox and differential

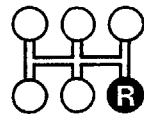
# DELTA-PRISMA 4WD

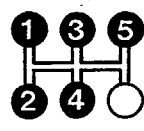

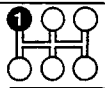
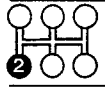
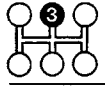
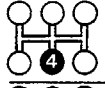
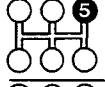
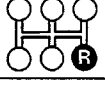

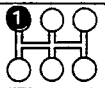
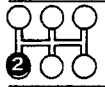
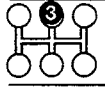
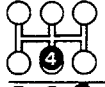
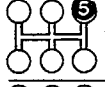
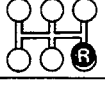
00.21-27

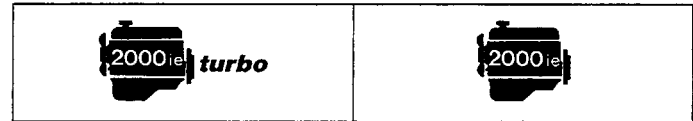
### GEARBOX

				
 Synchronizers	spring ring (Porsche type)		-	
	bauk ring type			
 Gears	straight toothed			
	helical toothed			
 Gear ratios			3,500	3,750
			2,235	2,235
			1,518	1,518
			1,132	1,132
			0,928	0,928
			3,583	3,583
 Crown wheel and pinion reduction			53/18 (2,944)	65/19 (3,421)
 Ratio at the wheels			10,304	12,828
			6,580	7,645
			4,468	5,193
			3,332	3,872
			2,732	3,174
			10,548	12,257

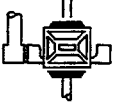

### CENTRE DIFFERENTIAL

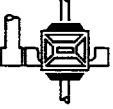

 Differential internal casing bearing	 conical roller bearings
 Adjustment of bearing pre-loading	 by shims
 LANCIA $\left( \begin{matrix} \text{Ladder} \\ 0,05 \end{matrix} \right)$ mm	1,00 ÷ 1,60
 Interference to obtain exact bearing pre-loading      mm	bearings not pre-loaded = 0,12 bearings pre-loaded (350 daN) = 0,08

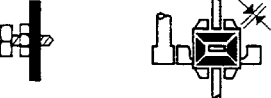
### FRONT DIFFERENTIAL

















 Clearance between satellite and planet gears      mm	$\leq 0,10$
 Adjustment of clearance between planet and satellite gears	no adjustment is carried out



00.21-27

 2000 turbo	 2000
---	--

### IDLER GEAR







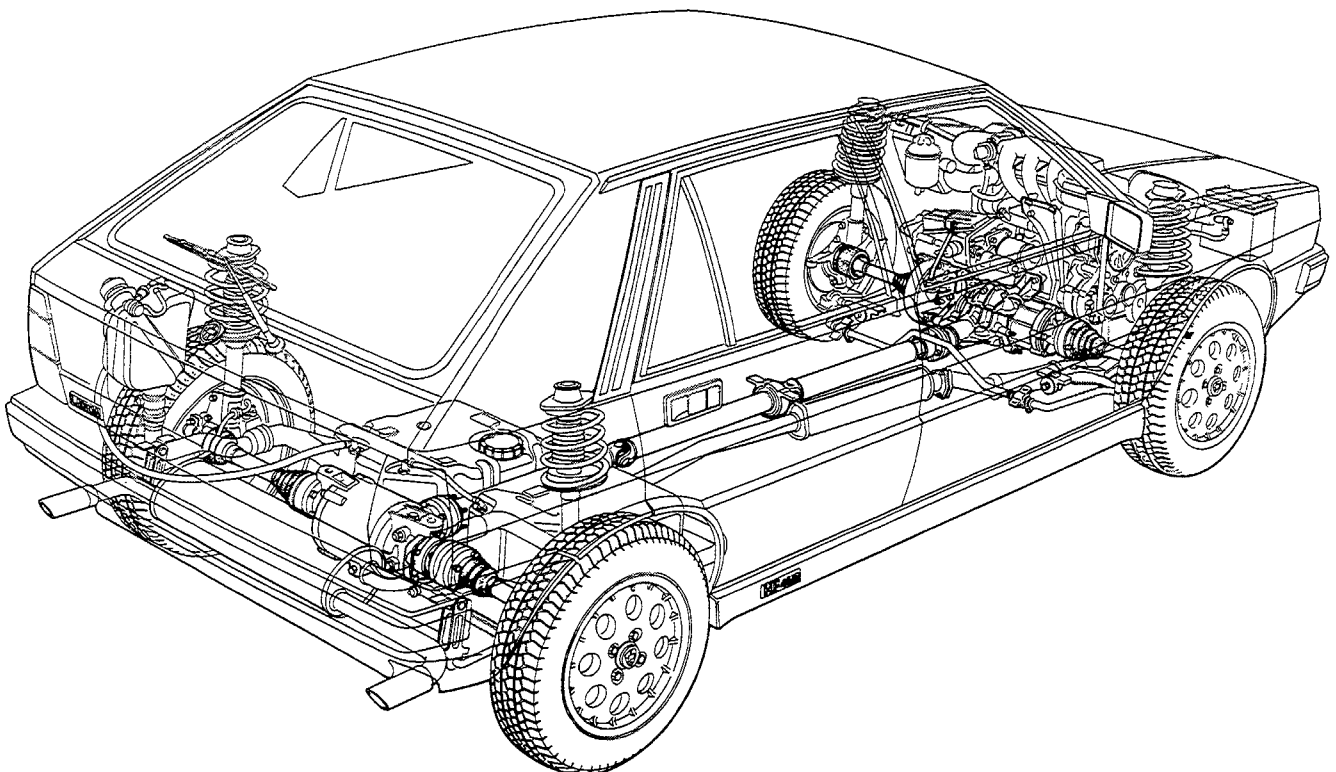





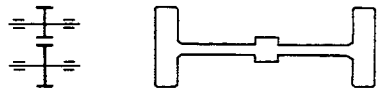

 <p>Spur gear set ratio</p>	43/19 (2,263)
 <p>Ring gear bearing rolling torque</p>	daNm 0,18 ÷ 0,20
 <p>Adjustment of ring gear bearings</p>	 by shims
 <p>Thickness of shims</p> <p>LANCIA (  0,025 ) mm</p>	1,475 ÷ 2,90
 <p>Adjustment of idler gear bevel pinion</p>	 by shims
 <p>Thickness of shims</p> <p>LANCIA (  0,02 ) mm</p>	2,55 ÷ 3,35
 <p>Bevel pinion bearing rolling torque</p>	daNm 0,08 ÷ 0,12
 <p>Clearance between pinion and ring gear</p>	mm 0,08 ÷ 0,15
 <p>Adjustment of clearance between pinion and ring gear</p>	 by shims
 <p>Thickness of shims</p> <p>LANCIA (  0,025 ) mm</p>	1,475 ÷ 2,90







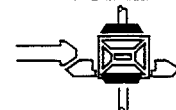

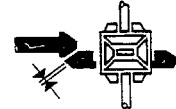

	
--	---

Type		in three sections
Supports		2 { 1 on the centre section with a ball bearing on the support 1 on the rear section with a ball bearing inside the support dust cover
Sliding constant velocity joints		1, on the front section
Universal joints		2, on the centre section
Splined joint		1, on the rear section
Spider radial clearance	mm	0,01 - 0,04
Thickness of shims for adjusting spider radial clearance	mm	1,50-1,53-1,56-1,59-1,62
Spline backlash	mm	0,175 - 0,350

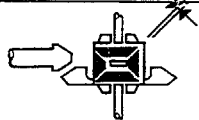

00.27

			
		19/43 (2,263)	
<b>Crown wheel and pinion reduction</b>			
		10,304	12,828
		6,580	7,645
		4,468	5,193
		3,332	3,872
		2,732	3,174
		10,548	12,257
<b>Ratio at the wheels</b>			
	daNm	0,08 ÷ 0,12	
<b>Bevel pinion bearings rolling torque</b>			
			
<b>Adjustment of bevel pinion position</b>		by shims	
	LANCIA $\left( \begin{array}{c} \text{A} \\ 0,05 \end{array} \right)$ mm	2,55 ÷ 3,35	
<b>Thickness of shims</b>			
			
<b>Differential internal casing bearing</b>		conical roller bearings	
	daNm	0,18 ÷ 0,20	
<b>Crown wheel bearings rolling torque</b>			
	mm	0,08 ÷ 0,15	
<b>Clearance between pinion and crown wheel</b>			

		
 Adjustment of clearance between pinion and crown wheel	 by shims	
 Adjustment of bearing pre-loading		
 LANCIA  0,05 mm Thickness of shims for differential internal casing bearings	0,18 ÷ 0,20	
 Clearance between planet and satellite gears	-	≤ 0,10
 Adjustment of clearance between planet and satellite gears	-	 by shims
 LANCIA  0,05 mm Thickness of shims	-	2,75 ÷ 3,25

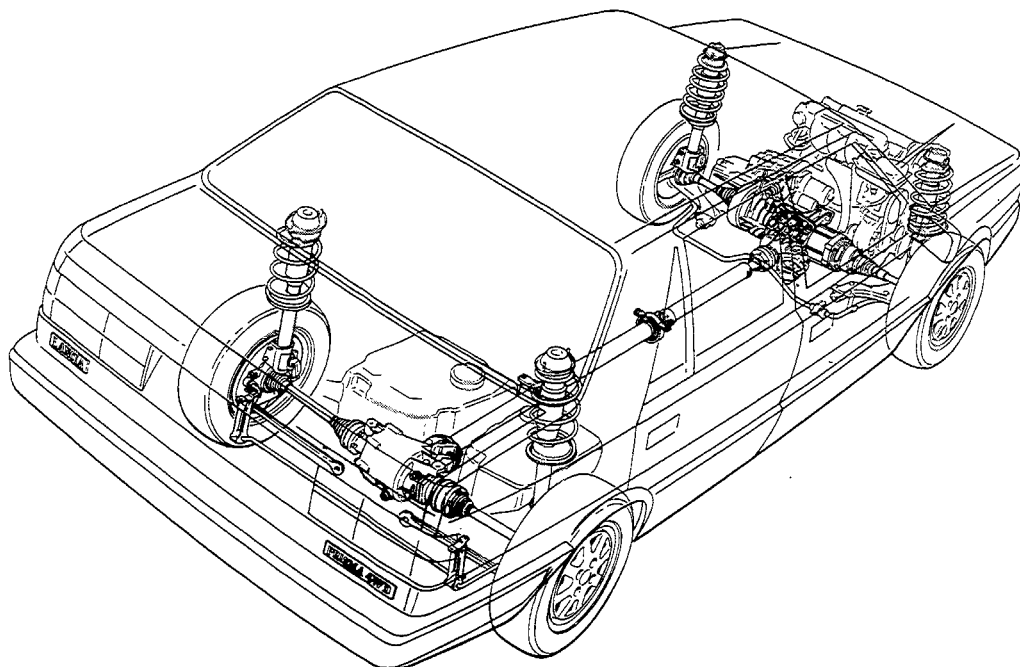

### 00.33









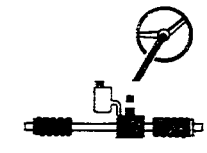
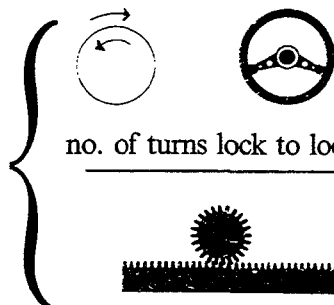

#### FRONT BRAKES

		Values in mm				
	Disc		Ø	257		
				19,20 ÷ 20,10	11,90 ÷ 12,10	
					18,55	11,30
				allowed	18,2	10,8
	Brake pads		allowed	1,5		
	Caliper	Ø	Ø	48		
	Master cylinder (pump)	Ø	Ø	19,05 (3/4")		
	Servo brake	ISOVAC 7" hydro-pneumatic vacuum servo acting on all four wheels				
	Distance of hydraulic piston push rod from master cylinder support plate	L	L	0,3 ÷ 0,5		

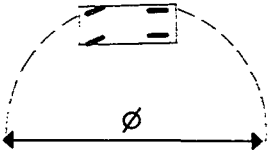
#### REAR BRAKES

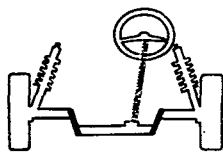

	Disc		Ø	227	
				10,70 ÷ 10,90	
					9,70
				allowed	9
	Brake pads		allowed	1,5	
	Caliper	Ø	Ø	34	
	Load proportioning valve	acting on the rear wheels			
	Ratio (reduction)			0,36	

		 2000 e turbo	 2000 e
Type		 rack and pinion power assisted	
Ratio	 no. of turns lock to lock	2,835	
	 rack travel	134 mm	
 $\varnothing$	Minimum turning circle	10,4 m	
Steering angle	 $\alpha_1$	outer wheel $\alpha_1$	30°46'
	 $\alpha_2$	inner wheel $\alpha_2$	35°4'
	Steering column	 with 2 universal joints	

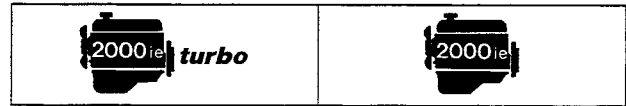
### 00.44



### WHEELS



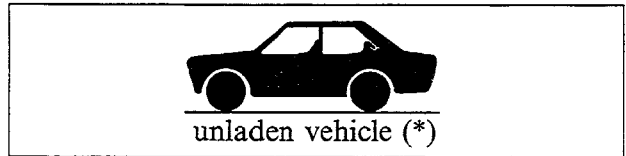
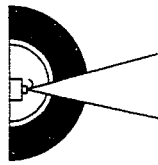

	Tyre	type			185/60 R14" 82 H 165/65 R14" 80 H*
			front	average load	2 bar
				heavy load	2,2 bar
			rear	average load	2 bar
heavy load	2,2 bar				
	Wheel rim	type	light alloy 5½ J x 14" AH2-45 5½ J x 14" H2-45*		

**NOTE** Spare wheel with 4J x 15" FH4 rim and 115/70 R15" XTL tyre  
Speed limit: 80 kph      Inflation pressure: 4,2 bar

(\*) Available on request

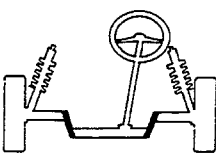

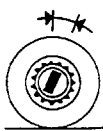
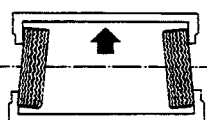
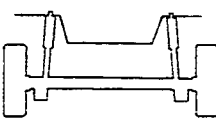

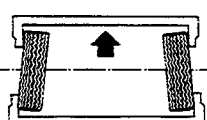
### WHEEL GEOMETRY

	camber (**)		$-40' \pm 30'$
	caster (**)		$3^{\circ}10' \pm 30'$
	toe in		$-0,5 \pm 1,5 \text{ mm } (\bullet)$
	camber (**)		$-55' \pm 30'$
	toe in		$2 \div 4 \text{ mm } (\bullet)$

(\*) With tyres inflated to the correct pressure and the vehicle in running order

(\*\*) Angles cannot be adjusted      (●) Measured on a 360 mm diameter

**Front suspension** independent, Mac Pherson type with lower track control arm and damper comprising double acting, hydraulic, telescopic shock absorber with offset coil spring.  
Stabilizer bar

Coil spring				
		Diameter of wire	mm	12,7 ± 0,05
Number of turns		5,4	5,4	
Direction of coil		clockwise		
Height of spring release	mm	436	445	
Height of spring under a load of:	378 daN	mm	205	–
	374 daN	mm	–	205
The springs are divided into two categories identifiable by a mark:				
yellow (1) for those under a load of:	378 daN	having a height of mm	> 205	–
	374 daN	having a height of mm	–	> 205
green (1) for those under a load of:	378 daN	having a height of mm	≤ 205	–
	374 daN	having a height of mm	–	≤ 205

(1) Springs of the same category must be fitted.

### Shock absorbers

Type: telescopic, hydraulic, double acting		Way-Assauto
Travel	mm	158
Maximum extension	mm	521,5





### 00.44

**Rear suspension** independent, Mac Pherson type with two transverse track control arms and a lower longitudinal track control arm plus a damper comprising a double acting, telescopic, hydraulic shock absorber with an offset coil spring.

Stabilizer bar

#### Coil spring



	
--	---

Diameter of wire	mm	11,9±0,05	11,6±0,05
Number of turns		3,86	3,86
Direction of coil		clockwise	
Height of spring released	mm	316	331
Height of spring under a load of:	258 daN	mm	173
	268 daN	mm	—
The springs are subdivided into two categories identifiable by a mark:			
yellow (1) for those under a load of:	258 daN	having a height of mm	> 173
	268 daN	having a height of mm	—
green (1) for those under a load of:	258 daN	having a height of mm	≤ 173
	268 daN	having a height of mm	—

(1) Springs of the same category must be fitted.

#### Shock absorbers

Type: telescopic, hydraulic, double acting		Way-Assauto
Travel	mm	190
Maximum extension	mm	590

	
--	---

<b>STARTER MOTOR</b>	M. Marelli E95 - 1,1 kW - 12 V
<b>ALTERNATOR</b>	M. Marelli AA125R - 14 V - 65 A
<b>VOLTAGE REGULATOR</b>	M. Marelli RTT 119 AC
<b>BATTERY</b>	12 V - 45 Ah - 225 A
<b>IGNITION SYSTEM</b>	Weber injection/ignition
<b>IGNITION DISTRIBUTOR</b>	DT 453 AX
<b>IGNITION COIL</b>	M. Marelli BAE 504 CK
<b>IGNITION COIL WITH POWER MODULE</b>	M. Marelli AEI 600 A
<b>SPARK PLUGS</b>	Fiat V45 LSR M. Marelli F8 LCR Bosch WR6 DC Champion RN7 YC

### 00.55



Motor: type	M. Marelli E95 - 1,1/12		
Voltage	V	12	
Nominal power	kW	1,1	
Rotation, pinon side	clockwise		
No. of poles	4		
Field coil	series-parallel		
Engagement	free wheel		
Operation	solenoid		
End float of armature shaft	mm	0,15 ÷ 0,45	
Data for bench test	Operating test (*):		
	current	A	270
	speed	rpm	1750
	voltage	V	9,2
	torque developed	daNm	0,65
	Engagement test (*):		
	current	A	530 ÷ 570
	voltage	V	6,6
	torque developed	daNm	≥ 1,6
Free running test (*):			
current	A	35 ÷ 45	
voltage	V	11,6 ÷ 11,7	
speed	rpm	8500 ÷ 9500	
Relay	Winding resistance (*)	pull in Ω	0,33 ÷ 0,37
		hold in Ω	1,13 ÷ 1,27
Lubrication	Internal splines and shaft bushes	VS+ SAE 10 W	
	Sleeve and intermediate disc	TUTELA MR3	

(\*) Data obtained at an ambient temperature of 20°C.

**NOTE** When overhauling it is not necessary to undercut the insulator between the commutator bars

STARTER MOTOR - TYPICAL CURVES

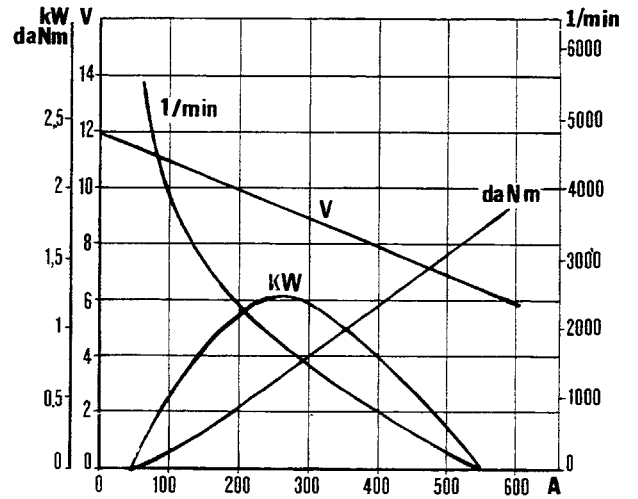

M. Marelli E95 - 1,1/12

Wiring diagram showing M. Marelli E95 - 1,1/12 starter motor

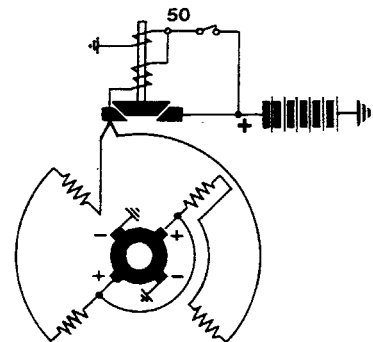

**00.55**

**ALTERNATOR**

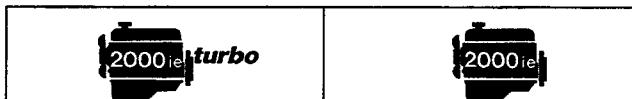

Make and type		M. Marelli AA125R-14V-65A
Nominal voltage	V	12
Maximum current	A	65
Cut in speed	rpm	1050 ÷ 1150
Current delivery on the battery at 7000 rpm	A	≥ 63
Field winding resistance, between the slip rings (*)	Ω	2,6 ÷ 2,8
Direction of rotation (as seen from the control side)		clockwise
Engine/alternator ratio		1 : 2
Rectifier diodes		bridge

(\*) Data obtained at an ambient temperature of 25°C

**VOLTAGE REGULATOR**

Type		Built in electronic RTT 119 AC
Alternator test speed	rpm	7000
Thermal stabilization current	A	30 ÷ 35
Test current	A	32 ÷ 33
Regulation voltage (*)	V	14 ÷ 14,3

(\*) Data obtained at an ambient temperature of 20°C

**BATTERY**

Nominal voltage	V	12
Capacity (20 hour discharge)	Ah	45

### ALTERNATOR – TYPICAL OUTPUT CURVES

(the data in these curves refer to outyut at a constant voltage of 13.5 V with bedded in brushes)

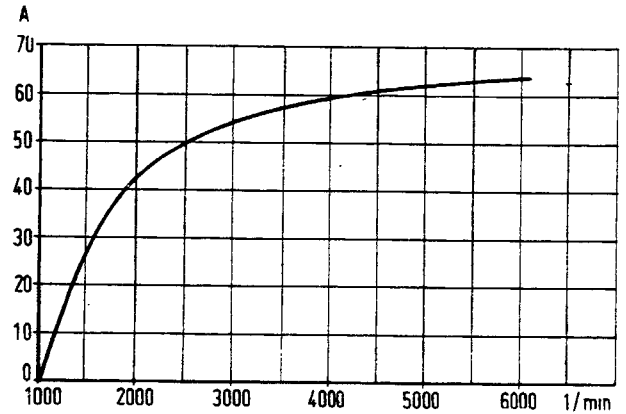

M. Marelli AA125R - 14 V - 65 A

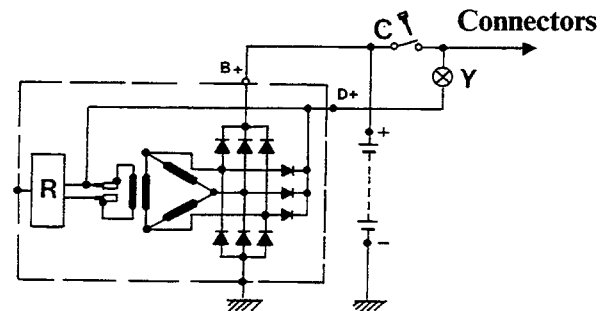

#### Marelli alternator wiring diagram

- C = Ignition switch with key
- Y = Alternator recharging warning light (12V - 3/5W)
- R = Electronic voltage regulator

#### FIMM RTT 119 AC voltage regulator typical curve

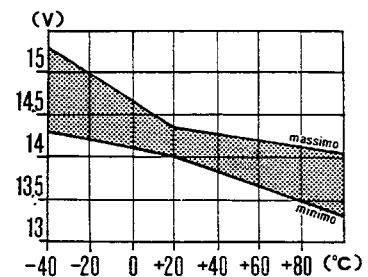

# Technical data

# DELTA-PRISMA 4WD

Electrical equipment: electronic injection/ignition

00.55

## POWER MODULE ELECTRONIC IGNITION

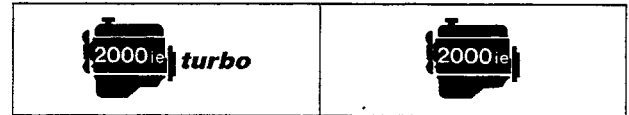

Make and type	M. Marelli AEI 600A
Firing order	1 - 3 - 4 - 2

## DISTRIBUTOR

Make	M. Marelli
Type	DT 453 AX
Built in rotor arm resistance $\Omega$	1000
Electro-magnetic impulse generator winding resistance at 20°C $\Omega$	758 $\div$ 872

## COIL

Make	M. Marelli
Type	BAE 504 CK
Primary winding resistance at 20°C $\Omega$	0,415 $\div$ 0,495
Secondary winding resistance at 20°C $\Omega$	4320 $\div$ 5280

## TDC AND RPM SENSOR

Make and type	M. Marelli SEN 8 D
Sensor winding resistance $\Omega$	612 $\div$ 748
Distance (gap) between sensor and crankshaft pulley teeth mm	0,4 $\div$ 1

## ENGINE ADVANCE

Minimum from 800 to 850 rpm at 0.43 bar (0,60 bar)*	15° $\pm$ 2°	18° $\pm$ 2° (*)
Maximum at 4000 rpm at 0.43 bar (0,299 bar)*	40° $\pm$ 2°	39° $\pm$ 2° (*)

## SPARK PLUGS

Make and type	Fiat V 45 LSR	Bosch WR 6 DC	Champion RN7YC	M.Marelli F8LCR
Thread	M 14 x 1,25			
Electrode gap	0,6 $\div$ 0,7 mm			

**IAW INJECTION SYSTEM COMPONENTS**

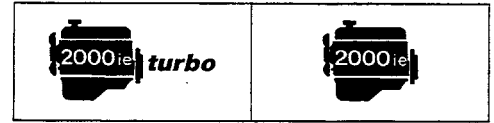

DESCRIPTION	QUANTITY	TYPE	
ELECTRONIC CONTROL UNIT	1	WH4E.03/085-F6 black label	WH26.03/HAI-BB yellow label
BUTTERFLY CASING	1	52 CFL 15	56 CFL 18
INJECTOR	4	IW 025/01	IW 024/03
ENGINE IDLE AUTOMATIC ADJUSTMENT SOLENOID VALVE	1	VAE 02	
PRESSURE REGULATOR	1	RP 1/3 bar	
AIR TEMPERATURE SENSOR	1	ATS 04	
WATER TEMPERATURE SENSOR	1	WTS 05	
ABSOLUTE PRESSURE SENSOR	1	APS 02/01	APS 03/01
BUTTERFLY VALVE POSITION SENSOR	1	PF 09/01	
FUEL FILTER	1	FI 02/01	
ELECTRIC FUEL PUMP	1	PI 022/2	



00.55

### DIAGRAM SHOWING INJECTION/IGNITION CONTROL UNIT CONNECTIONS (CONCERNING ELECTRONIC IGNITION ONLY)

The identification numbers for the components are the same as those given in the wiring diagrams

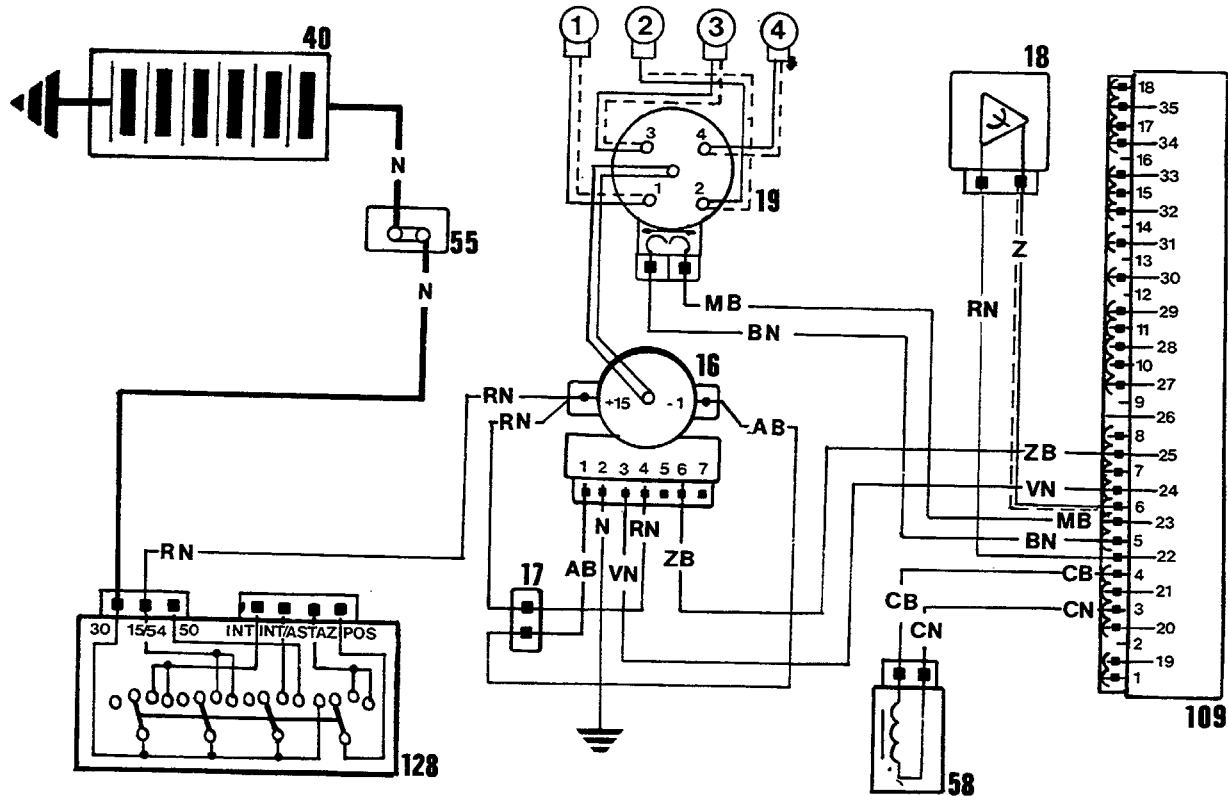

- 16. Ignition coil with power module
- 17. Connection
- 18. Anti-detonation sensor
- 19. H.T. distributor with built in timing sensor
- 40. Battery
- 55. Connector
- 58. Rpm and TDC sensor
- 109. Injection/ignition electronic control unit
- 128. Ignition switch

### CHARACTERISTIC IGNITION ADVANCE CURVES FOR EIGHT VACUUM VALUES IN THE INLET MANIFOLD

at an absolute pressure of 0,18 bar (135 mmHg)

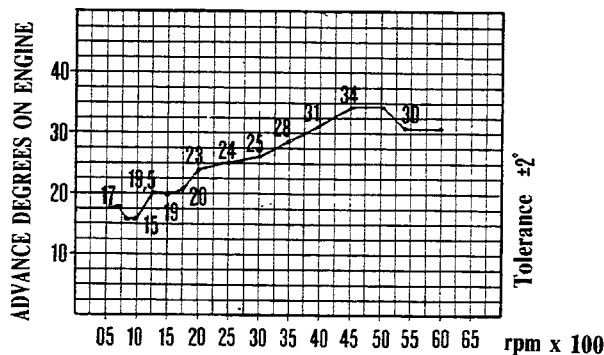

at an absolute pressure of 0,299 bar (225 mmHg)

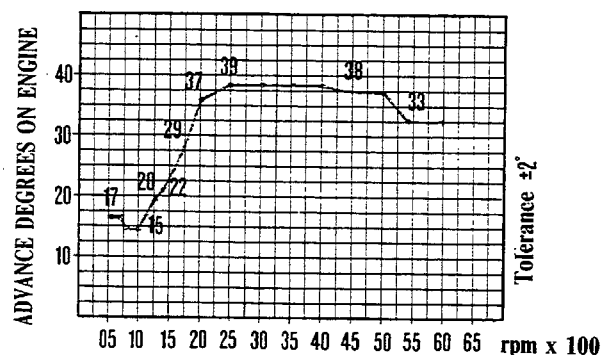

at an absolute pressure of 0,43 bar (321 mmHg)

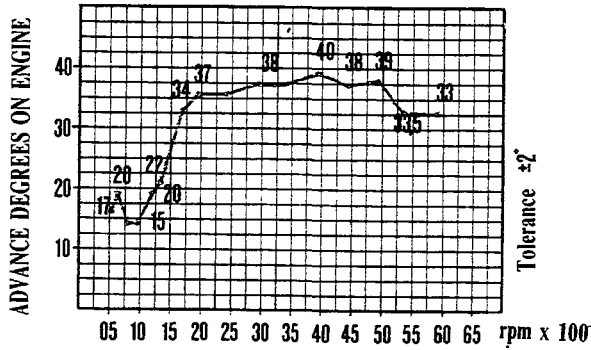

at an absolute pressure of 0,54 bar (405 mmHg)

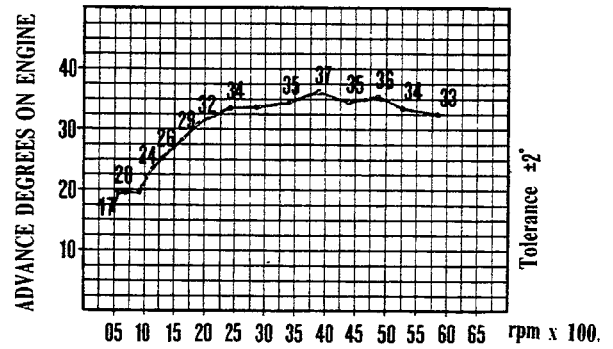

at an absolute pressure of 0,70 bar (525 mmHg)

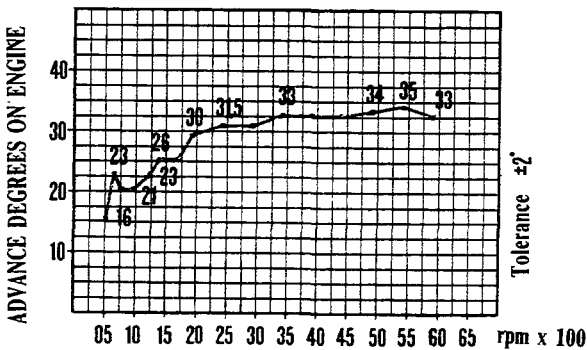

at an absolute pressure of 0,92 bar (690 mmHg)

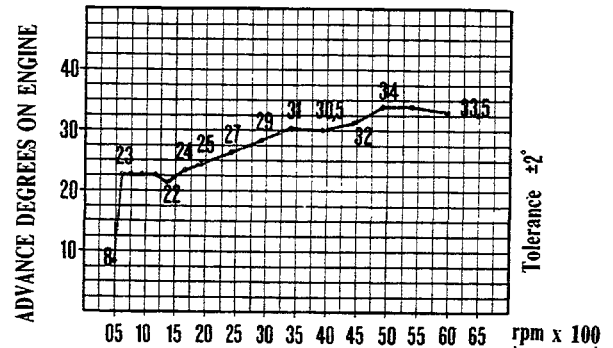

at an absolute pressure of 1,38 bar (1035 mmHg)

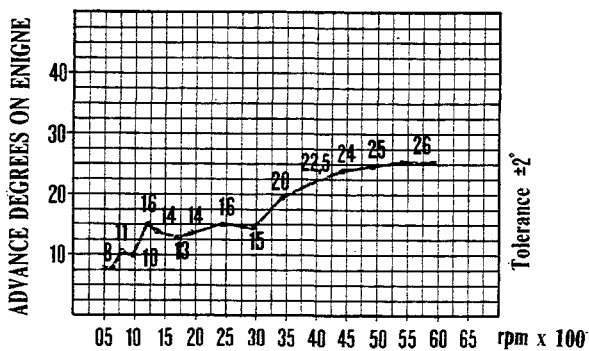

at an absolute pressure of 1,80 bar (1350 mmHg)

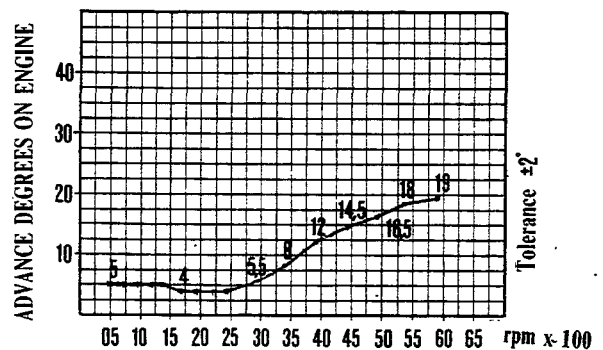

### 00.55

#### DIAGRAM SHOWING INJECTION/IGNITION CONTROL UNIT CONNECTIONS (CONCERNING ELECTRONIC IGNITION ONLY)

The identification numbers for the components are the same as those used in the wiring diagrams

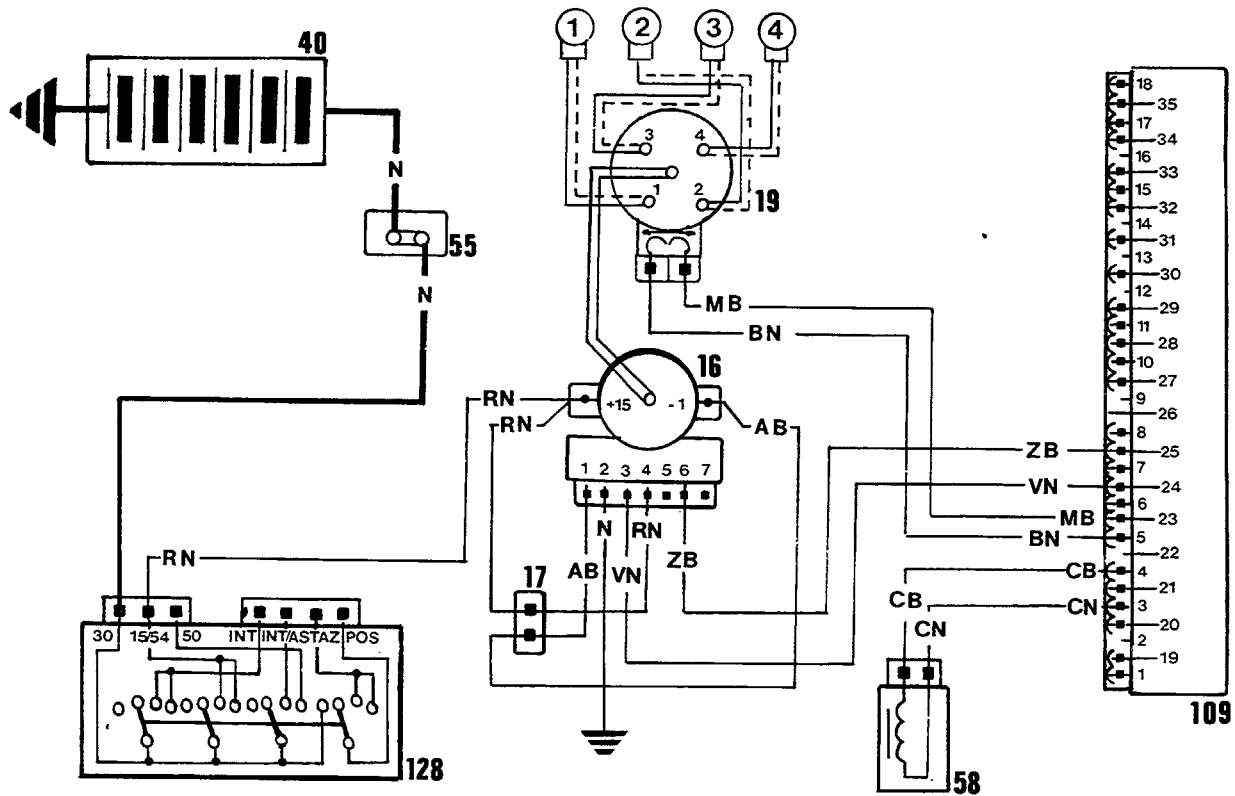

- 16. Ignition coil with power module
- 17. Connection
- 19. H.T. distributor with built in timing sensor
- 40. Battery

- 55. Connector
- 58. Rpm and TDC sensor
- 109. Injection/ignition electronic control unit
- 128. Ignition switch

#### CHARACTERISTIC IGNITION ADVANCE CURVES FOR EIGHT VACUUM VALUES IN THE IN-LET MANIFOLD

at an absolute pressure of 0,17 bar (129 mmHg)

at an absolute pressure of 0,299 bar (225 mmHg)

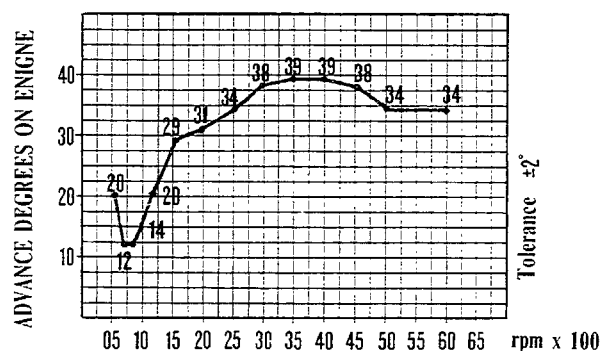
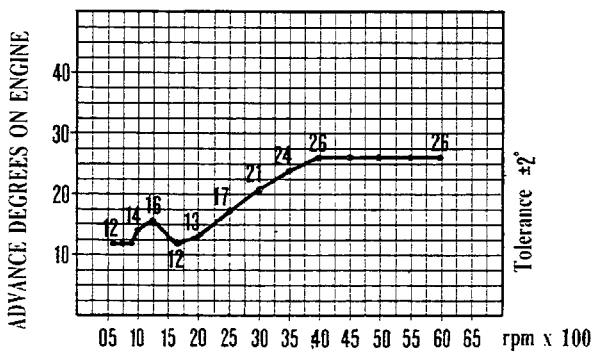

at an absolute pressure of 0,39 bar (294 mmHg)

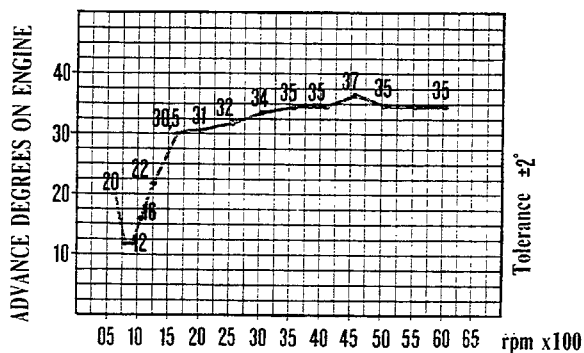

at an absolute pressure of 0,53 bar (399 mmHg)

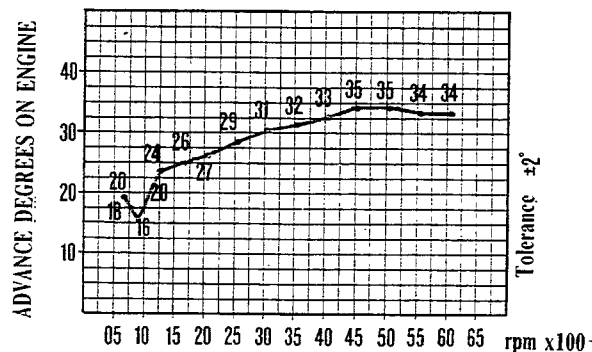

at an absolute pressure of 0,60 bar (450 mmHg)

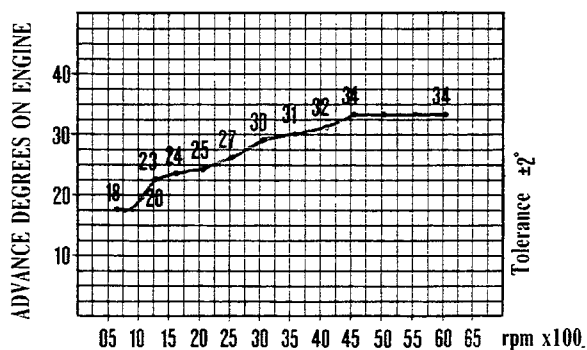

at an absolute pressure of 0,73 bar (549 mmHg)

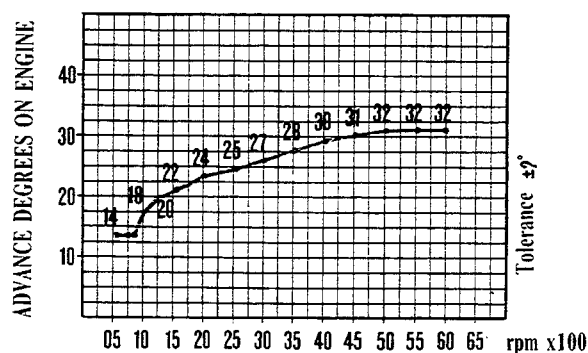

at an absolute pressure of 0,82 bar (615 mmHg)

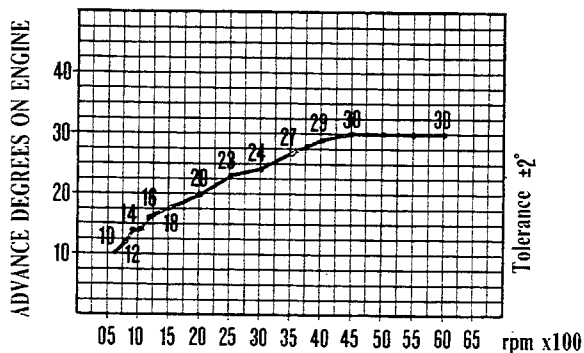

at an absolute pressure of 0,82 bar (619 mmHg)

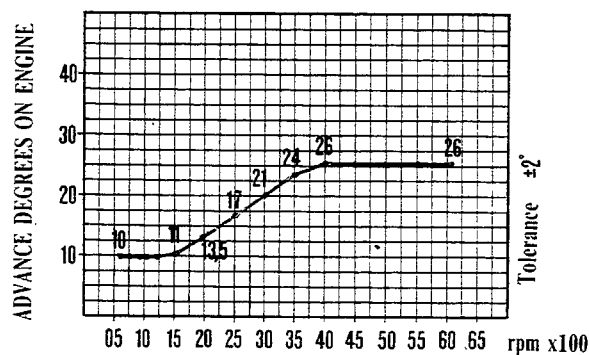

00.55

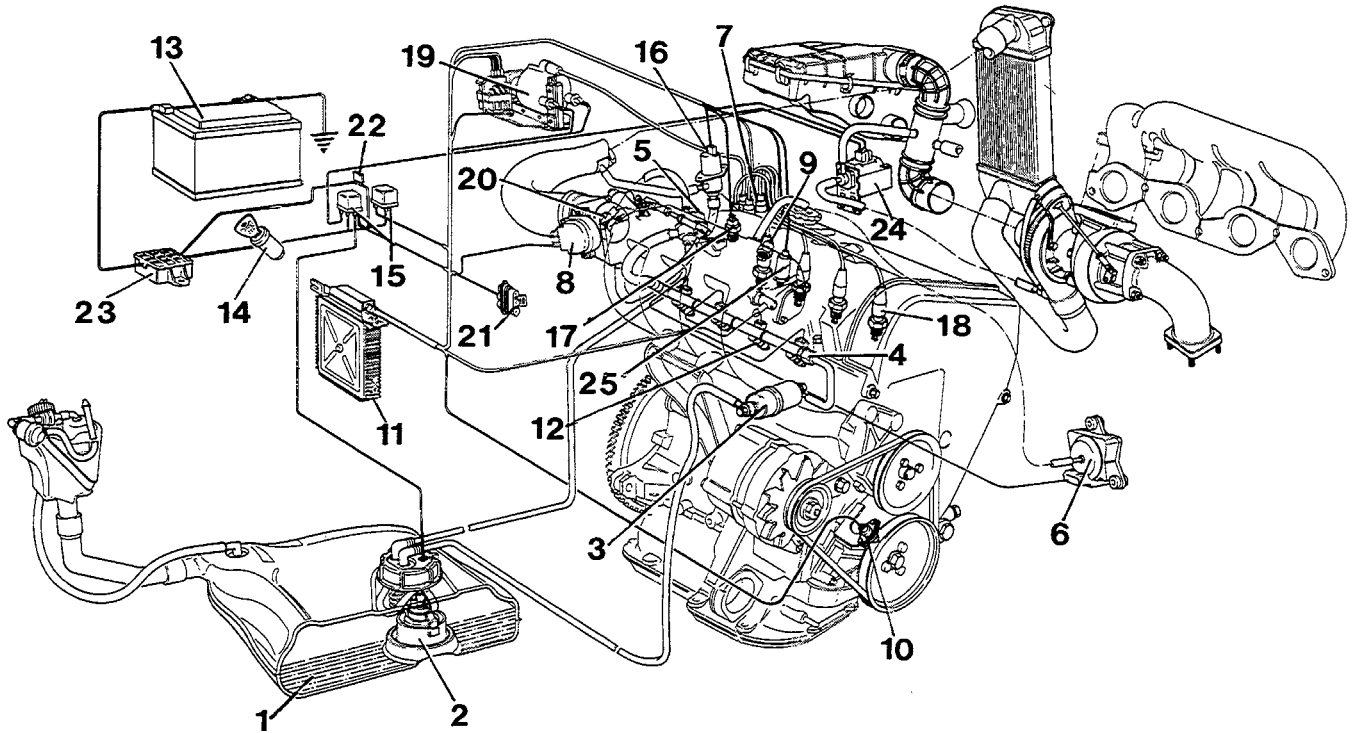

Diagram showing IAW injection/ignition system

1. Fuel tank
2. Electric fuel pump
3. Fuel filter
4. Fuel inlet
5. Fuel pressure regulator
6. Absolute air pressure sensor
7. HT distributor with injection timing sensor
8. Butterfly valve position sensor
9. Inlet air temperature sensor
10. Rpm and TDC sensor
11. Electronic control unit
12. Injector
13. Battery
14. Ignition switch
15. Injection/ignition relays
16. Additional air solenoid valve for automatic adjustment of engine idling
17. Coolant temperature sensor
18. Spark plugs
19. Ignition unit
20. Butterfly valve
21. Diagnostic socket
22. W.I.I. system protective fuse
23. Vehicle electrical system connector
24. Overboost solenoid valve
25. Detonation sensor

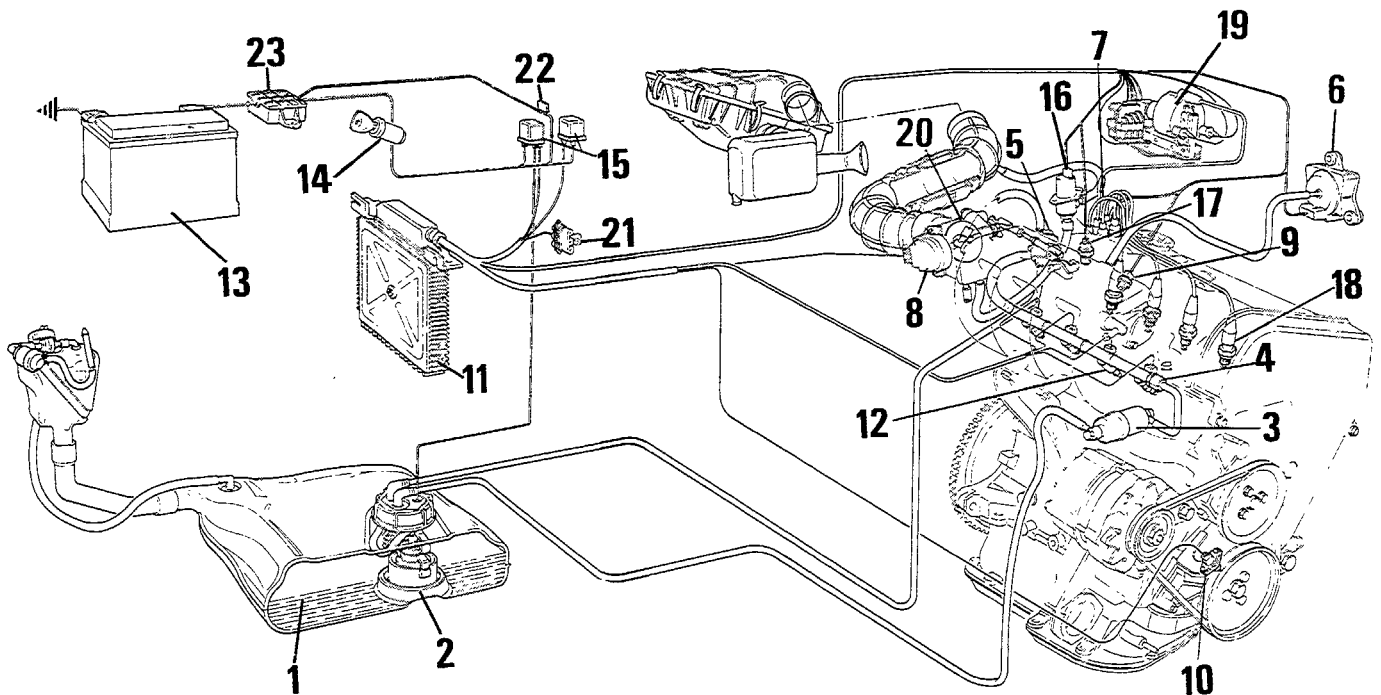

Diagram showing IAW injection/ignition system

- |  |   |
|--|---|
| 1. Fuel tank                                   | 15. Injection/ignition relays   |
| 2. Electric fuel pump                          | 16. Additional air solenoid valve for automatic adjustment of engine idling |
| 3. Fuel filter                                 | 17. Coolant temperature sensor  |
| 4. Fuel manifold                               | 18. Spark plugs   |
| 5. Fuel pressure regulator                     | 19. Ignition unit   |
| 6. Inlet air absolute pressure sensor          | 20. Butterfly valve   |
| 7. HT distributor with injection timing sensor | 21. Diagnostic socket (located near injection control unit connector)       |
| 8. Butterfly valve position sensor             | 22. IAW system protective fuse  |
| 9. Inlet air temperature sensor                | 23. Vehicle electrical system connector                                     |
| 10. Rpm and TDC sensor                         |   |
| 11. Electronic control unit                    |   |
| 12. Injectors                                  |   |
| 13. Battery                                    |   |
| 14. Ignition switch                            |   |