

**REMOVAL-REFITTING**

- Procedure 1

**DELTA 4WD****BENCH DISASSEMBLY**

- Procedure 3
- Left differential housing cover 7
- Right differential housing cover 9

**“TORSEN” differential**

- Removing-refitting-checks 10

**ASSEMBLY**

- Procedure 14
- Procedure for calculating thickness of rear bearing thrust ring on bevel pinion 16
- Bevel gear rolling torque 17
- Bevel pinion rolling torque 18
- Checking pinion-crown wheel backlash 19
- Checking and adjusting pinion-bevel gear contact pattern 20

**“TORSEN” unit**

- General 22
- Operation 23

**PRISMA 4WD**

- Differential lock diagram 24

**BENCH DISASSEMBLY**

- Procedure 25
- Left differential housing cover 29
- Right differential housing cover 31

**Differential unit**

- Removal-refitting-checks 32

**ASSEMBLY**

- Procedure 34
- Procedure for calculating thickness of rear bearing thrust ring on bevel pinion 37
- Bevel gear rolling torque 38
- Bevel pinion rolling torque 39
- Checking pinion-crown wheel backlash 40
- Checking and adjusting pinion and gear tooth contact pattern 41
- Lock device 43

**TIGHTENING TORQUES**

44



## PROCEDURE

Position car on lift.

Proceed as follows:

- remove back wheels;
- raise lift and, working from underneath the car, drain oil from differential;
- then proceed as follows:

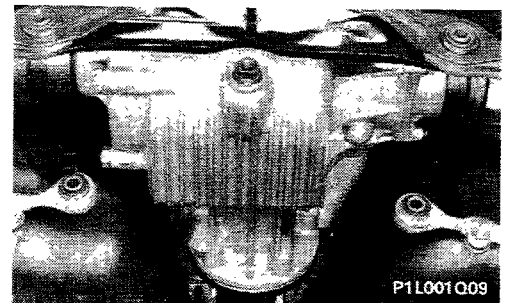
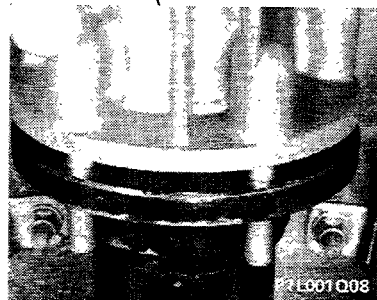
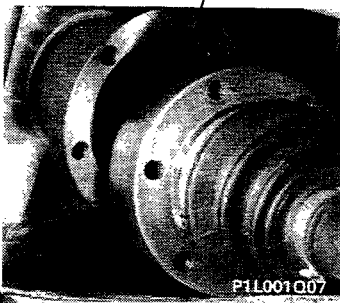
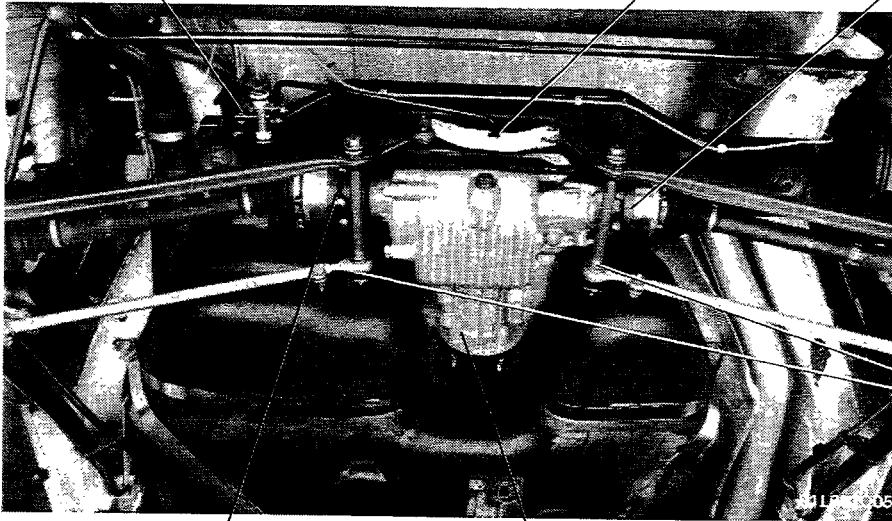
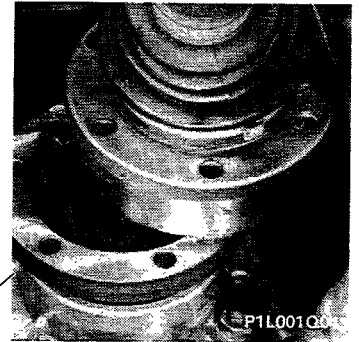
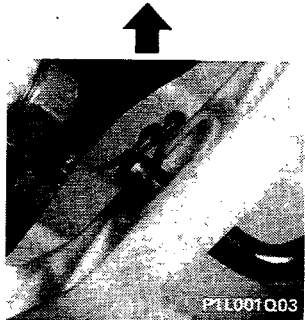
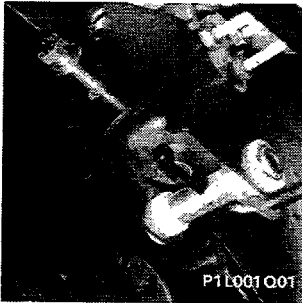
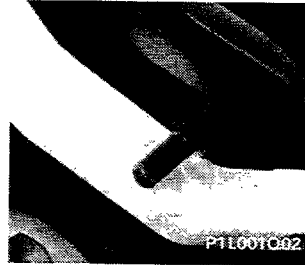

# Rear differential

## Removal-refitting

# DELTA-PRISMA 4WD

27.

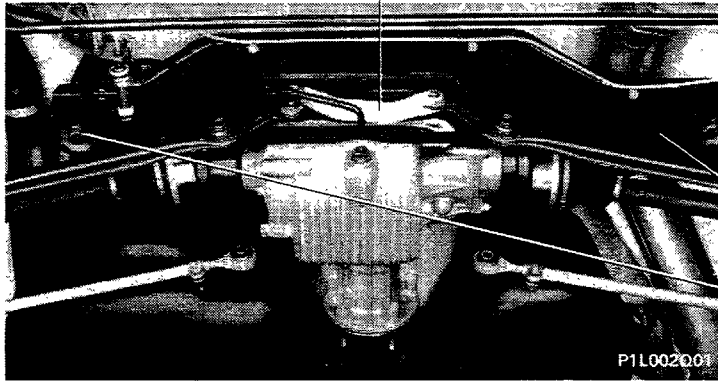

P1L002Q04

Position hydraulic jack under differential unit, then proceed as follows:

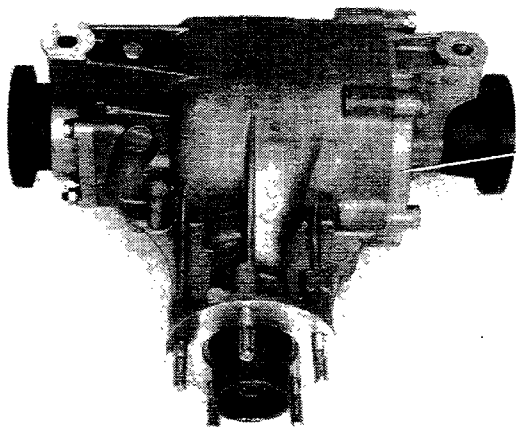
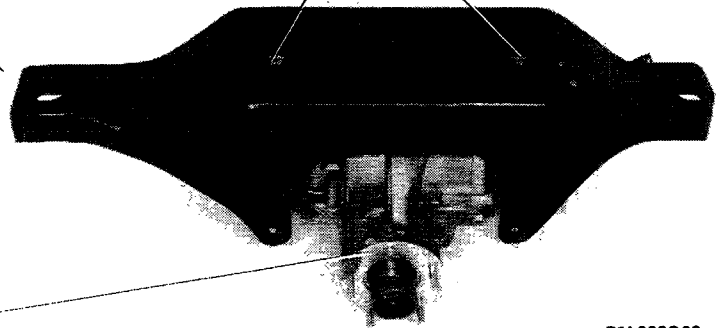
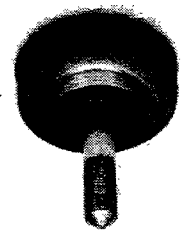
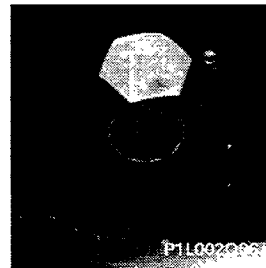
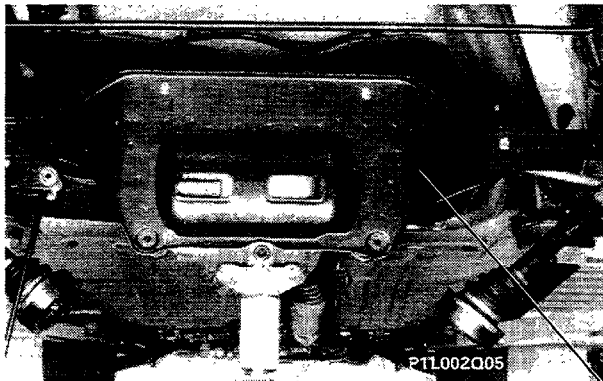

**NOTE** *When refitting rear differential unit, carry out removal operations in reverse order.*

### PROCEDURE

Position differential unit on stand 1870436000 secured in clamp for overhaul; then proceed as follows:

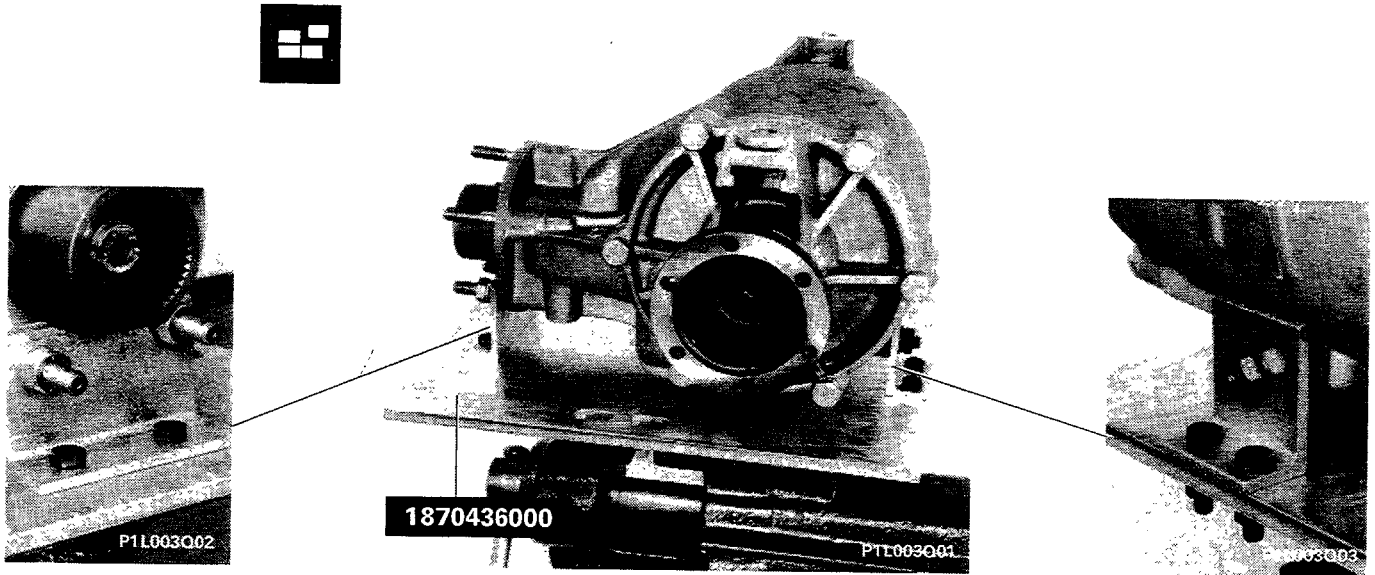

Points for securing differential unit to overhaul stand 1870436000

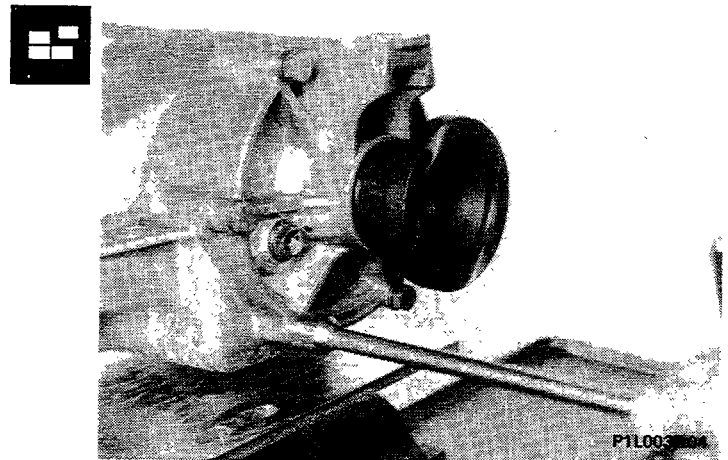

Removing left side of cover complete with shaft

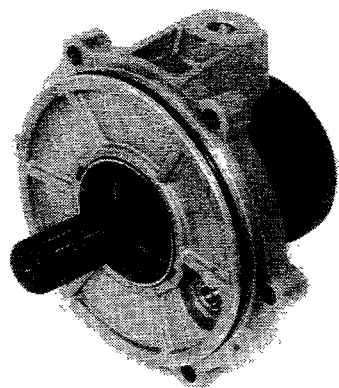

P1L003Q06

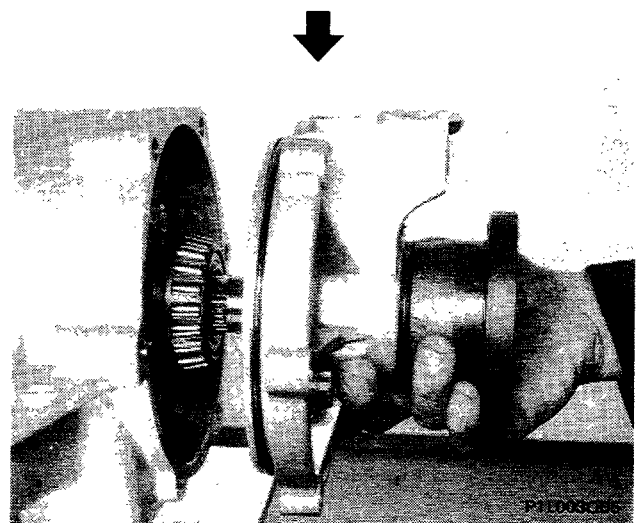

P1L003Q05



27.

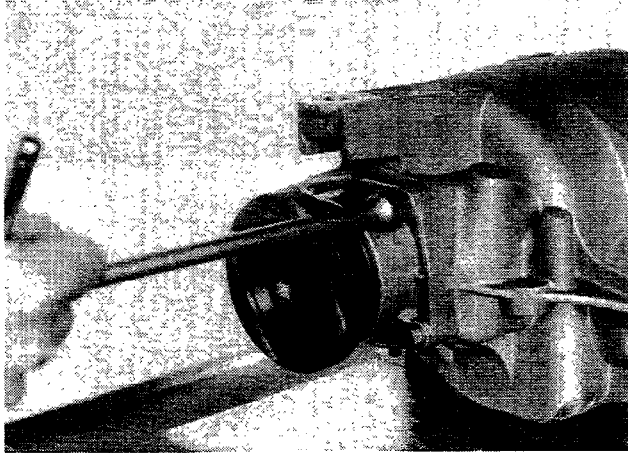

Removing right side of cover complete with shaft

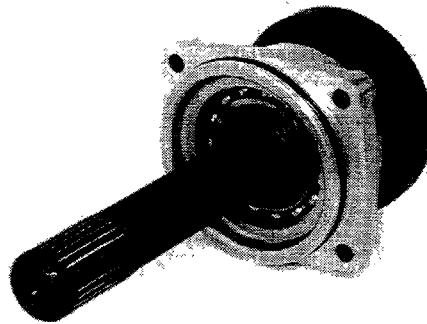
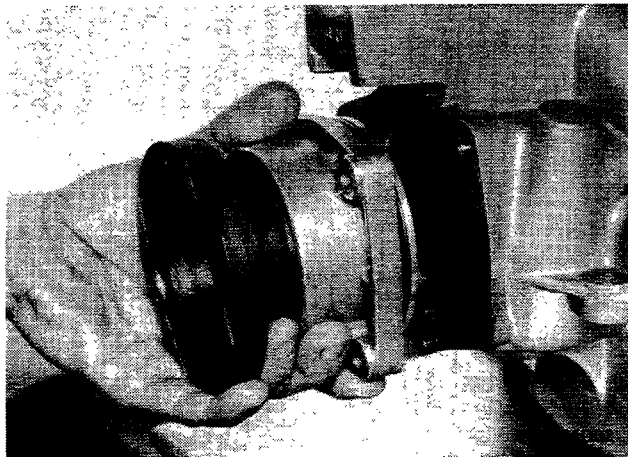

P1L004Q03

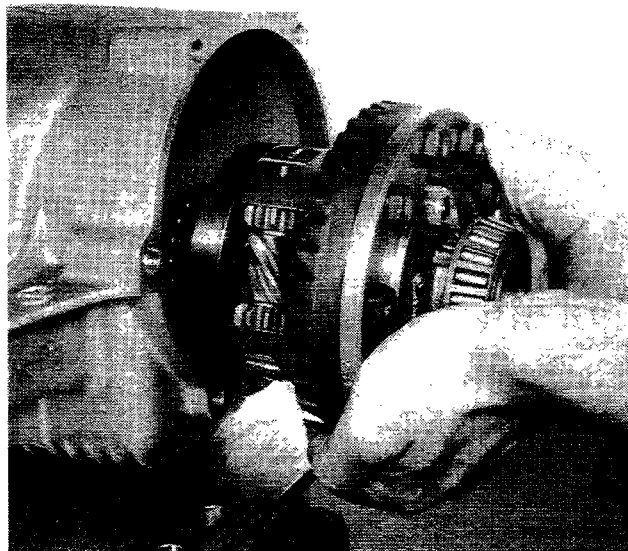

Removing "TORSEN" differential from housing

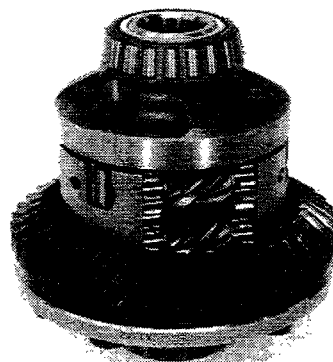

P1L004Q05





**Removing pinion retaining nut**

**NOTE** *When removing pinion retaining nut, prevent pinion from turning using tool 1870441000 as shown in the diagram.*

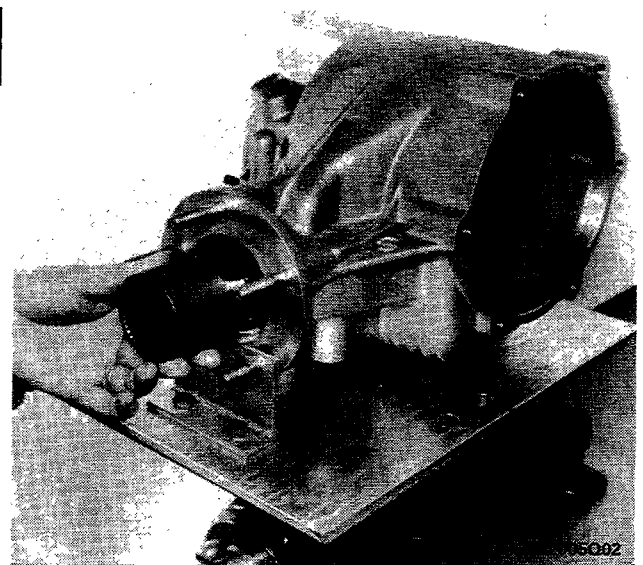
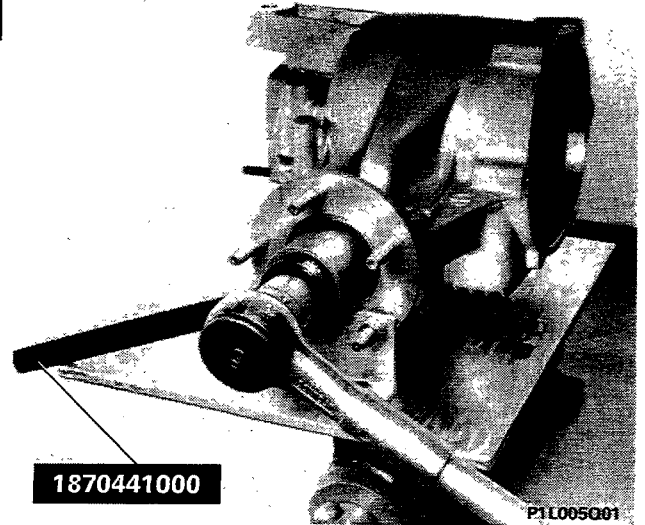

**Remove toothed sleeve from pinion**

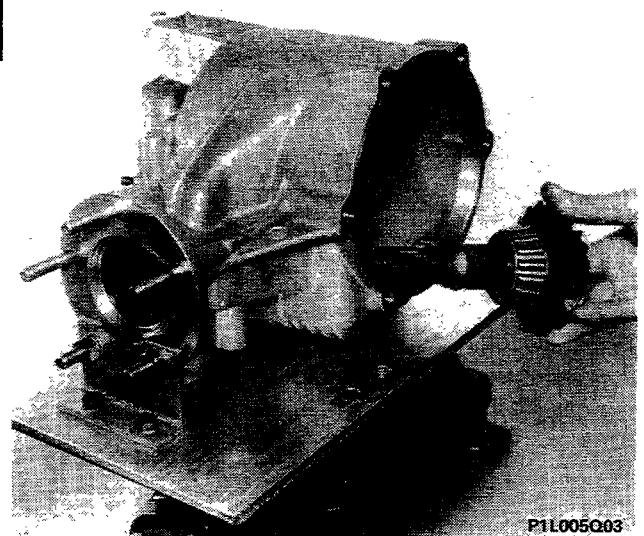

**Remove pinion complete with bearing and compressible spacer from housing**



27.

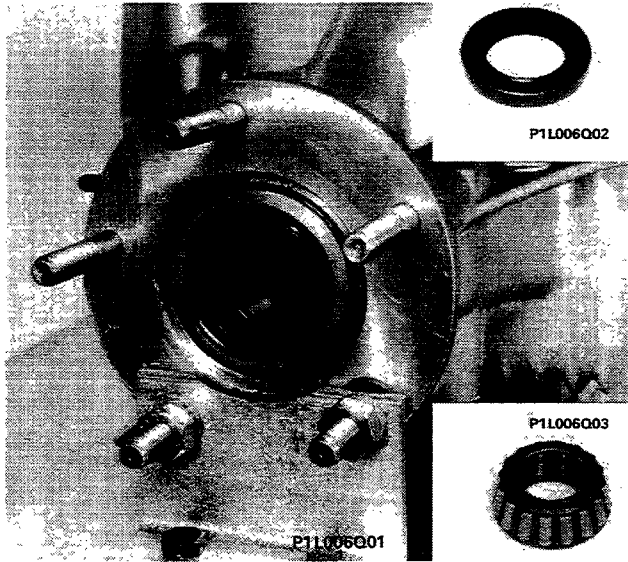

Removing differential pinion gasket and bearing

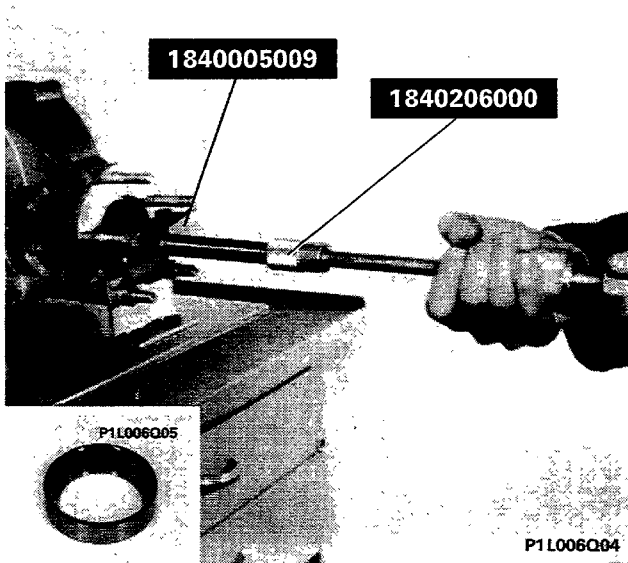

Removing differential pinion bearing outer race

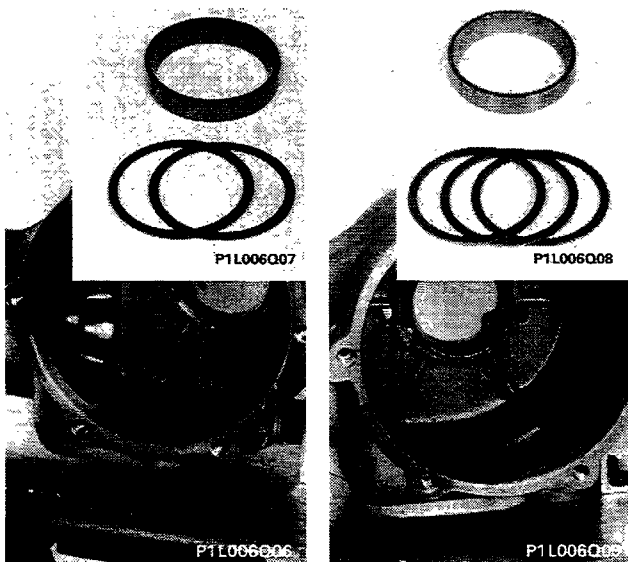

Removing bearing outer races with shims for pinion and crown wheel



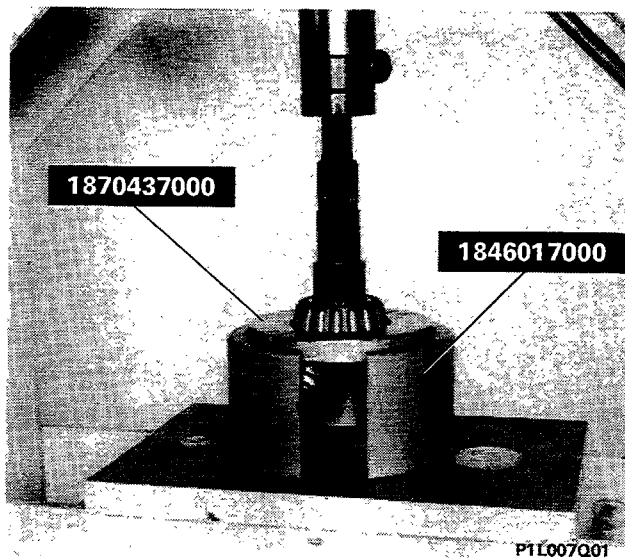

P1L007Q01

Removing pinion rear bearing inner race using hydraulic press

**LEFT DIFFERENTIAL HOUSING COVER**

Removal-refitting and checks

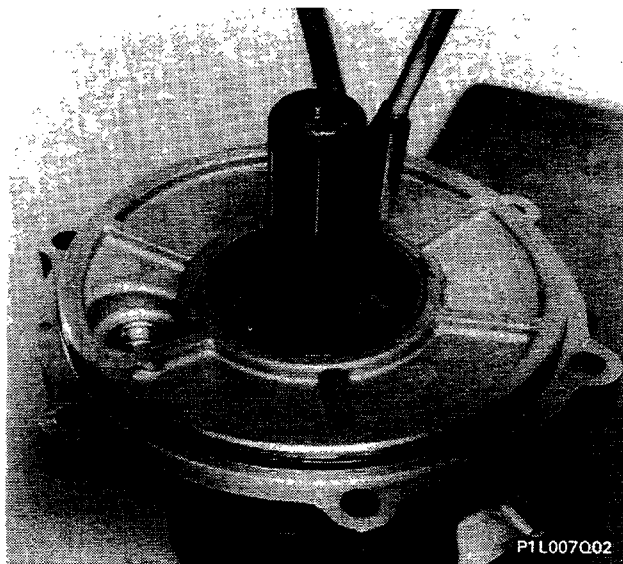

P1L007Q02

Removing-refitting drive shaft sealing ring to cover

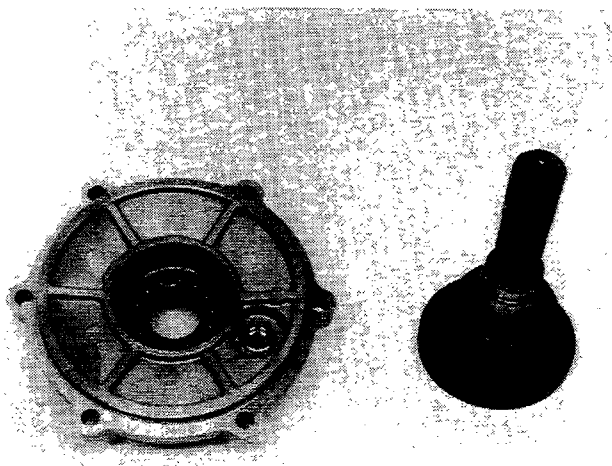

P1L007Q03

View of left cover separated from drive shaft

**NOTE** Check that the drive shaft is not distorted and that surfaces and splines are not damaged. Replace if necessary.

27.

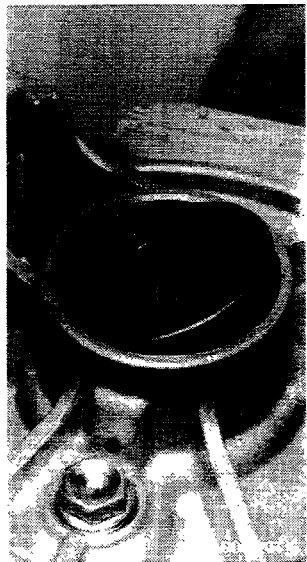

### Removing-refitting left drive shaft seal

Use tool 1870100002 to fit seal as shown in diagram.

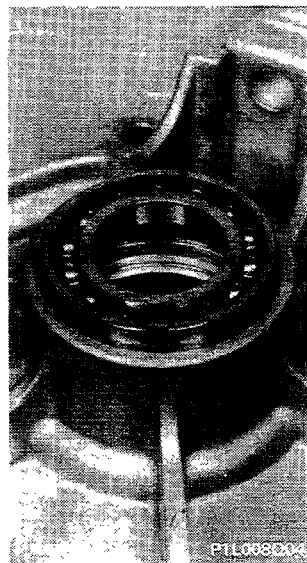
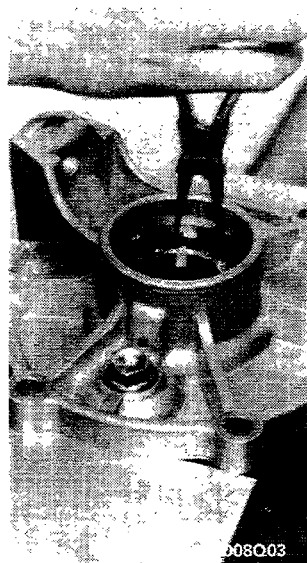

### Removing-refitting retaining ring and left drive shaft ball bearing

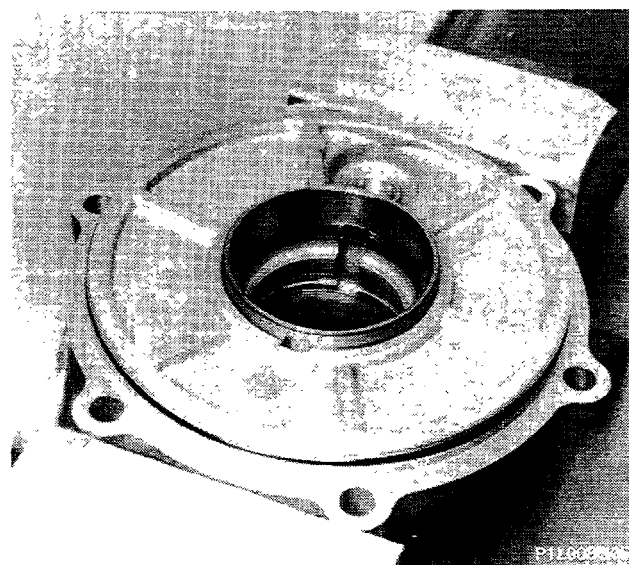

### Removing-refitting "Torsen" differential support ball bearing outer race



**RIGHT DIFFERENTIAL HOUSING COVER**

Removing-refitting and checking

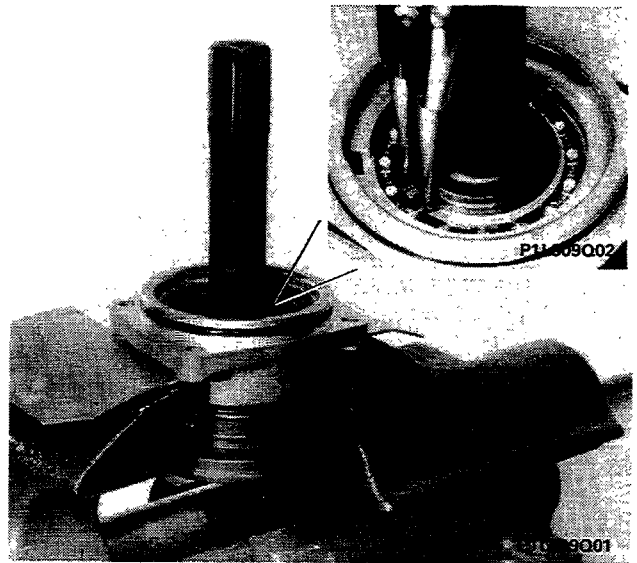

**Removing right drive shaft sealing ring**



View of right cover separated from drive shaft

**NOTE** Check that drive shaft is not distorted and that surfaces and splines are not damaged. Replace if necessary.

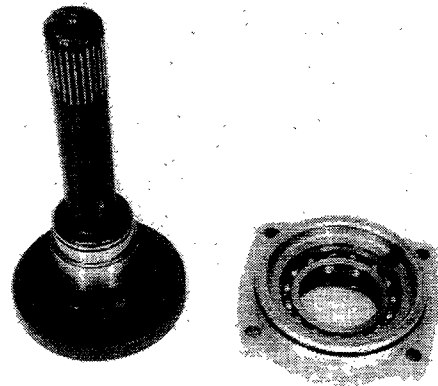

P1L009Q03



**Removing-refitting retaining ring and right drive shaft ball bearing**

**Fitting right drive shaft seal**

27.

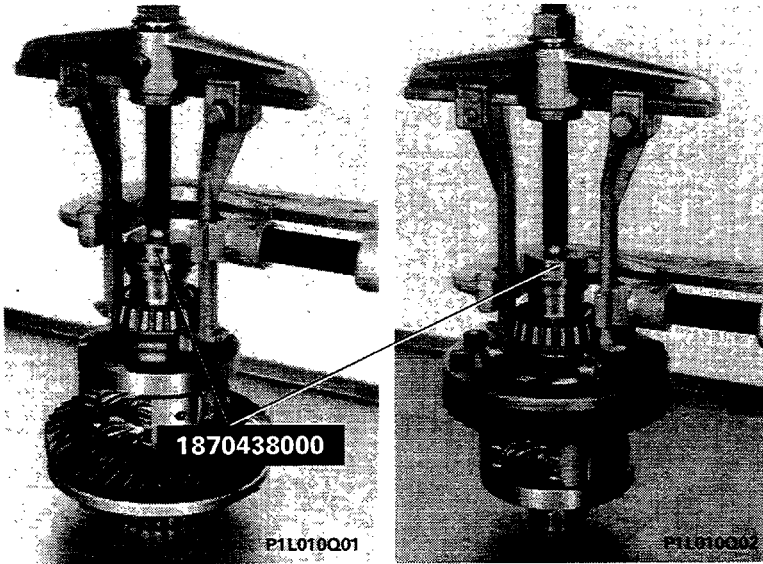

“TORSEN” differential  
Removing-refitting and checking

Removing roller bearings from differential unit

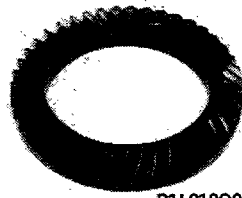
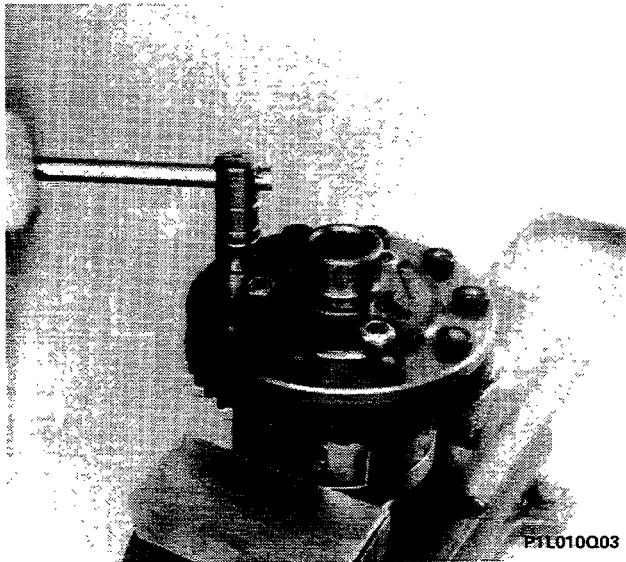

Removing crown wheel from differential unit

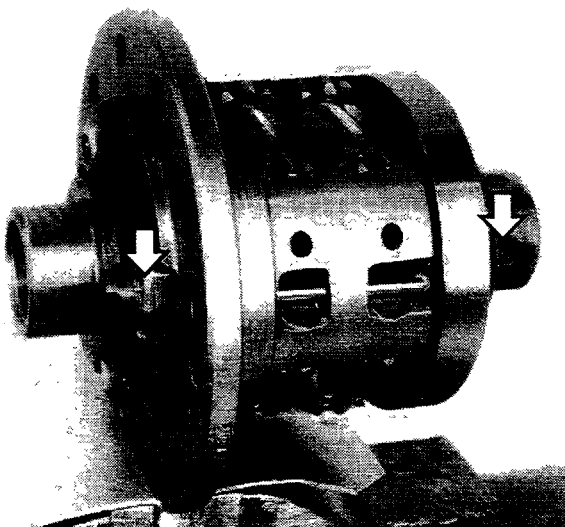

Removing-refitting bolts retaining cover to “Torsen” differential cover



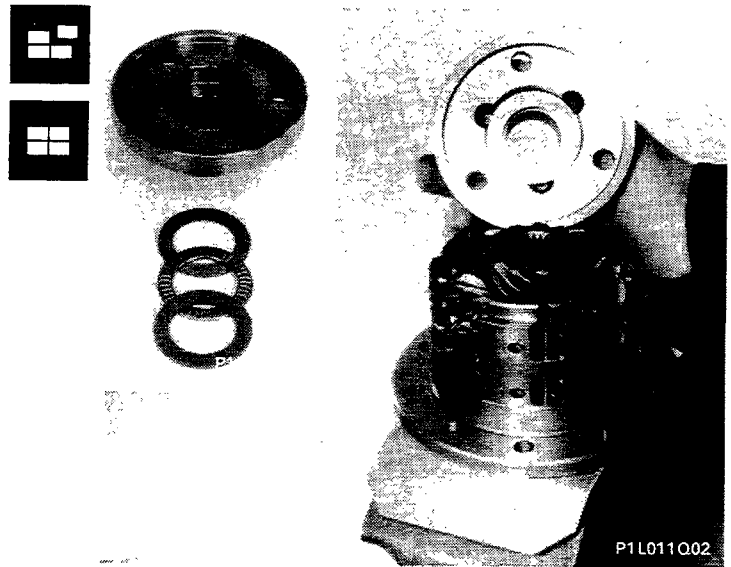

Removing-refitting differential casing cover complete with roller bearings

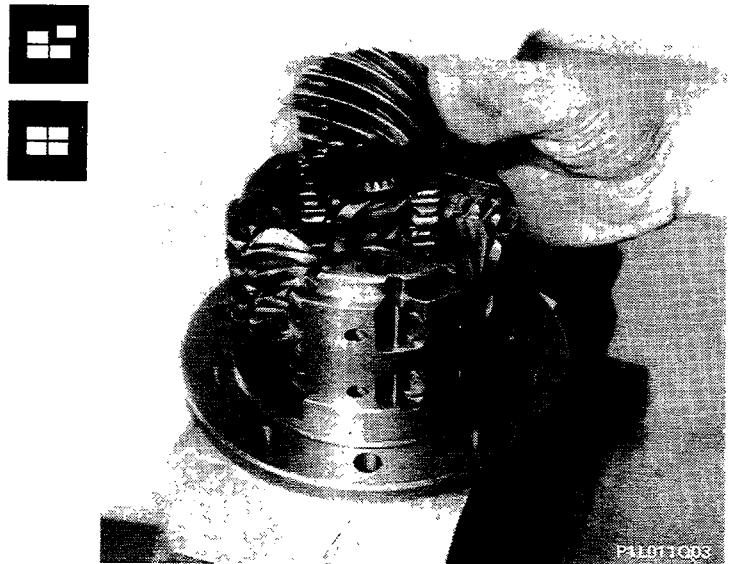

Removing-refitting planet wheel from differential casing



Removing-refitting satellite carrier shaft retaining pin

27.

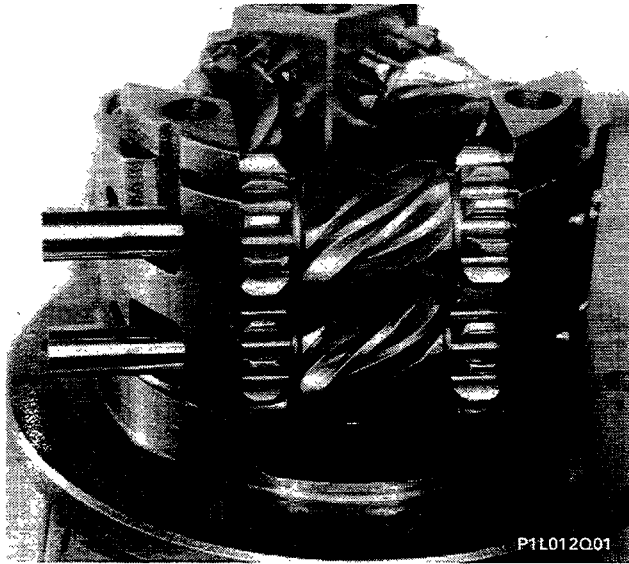

Removing-refitting satellite carrier shafts

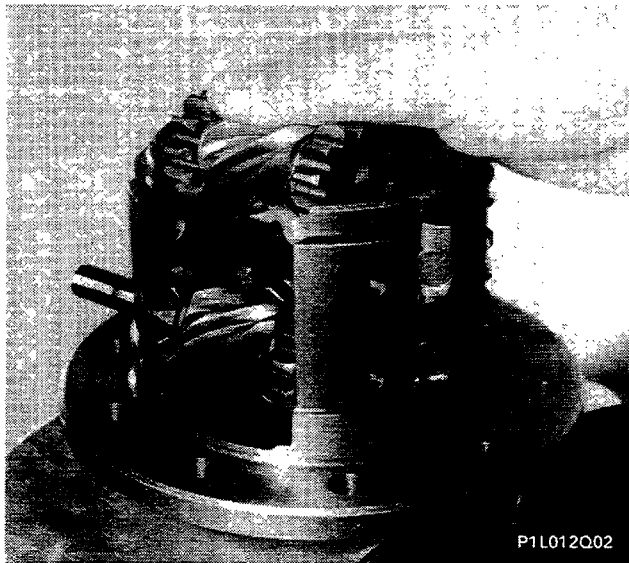

Removing-refitting satellites from differential casing

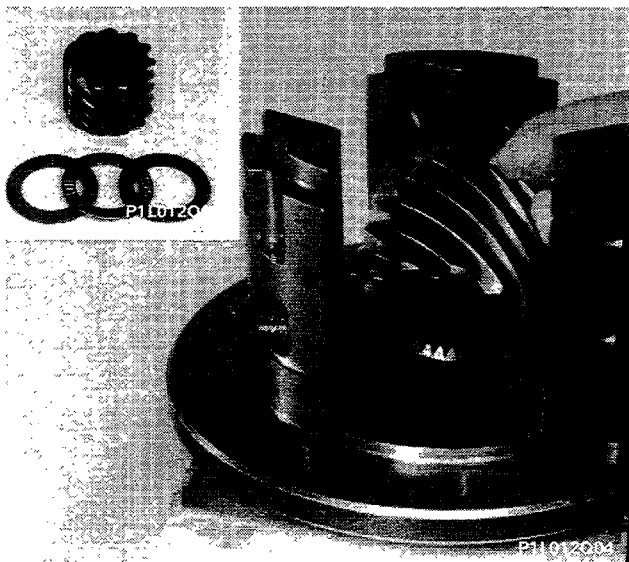

Removing-refitting planet wheel complete with roller bearing from differential casing



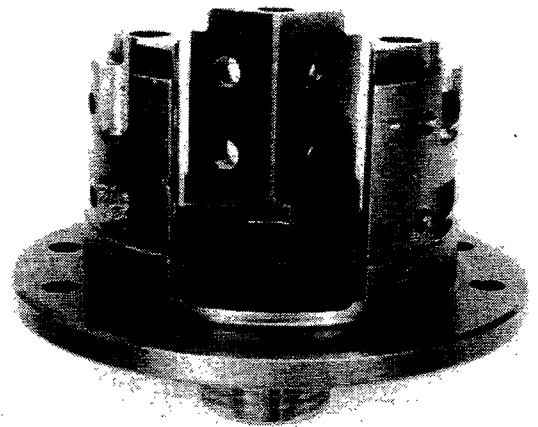

P1L013Q01

**“Torsen” differential casing**

**NOTE** *The differential casing should not be cracked. Bearing seats should not be worn or damaged. Replace if necessary.*

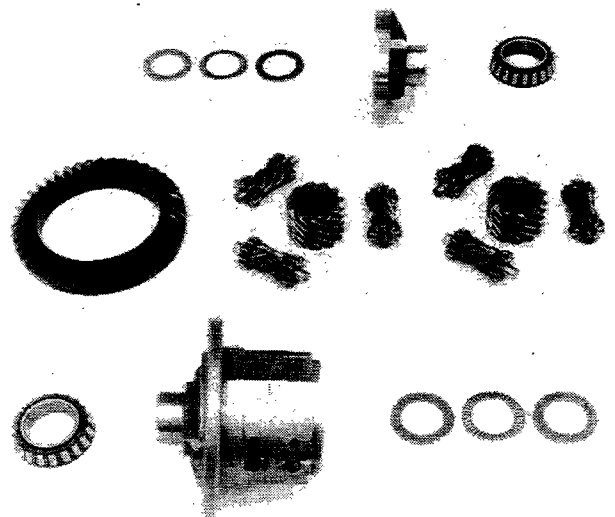

P1L013Q02

**Components of “Torsen” differential unit**

Gear working surfaces should not be worn or chipped. Whenever crown wheel replacement is necessary, replace bevel pinion as well, or vice versa.

Bearings should be replaced whenever they show signs of scoring, hot spots or excessive wear.

**8 daNm**

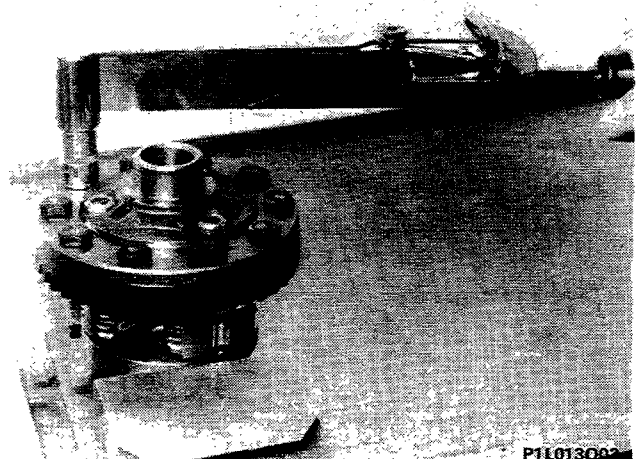

P1L013Q03

**Installation and torque tightening of crown wheel**

## 27.



### PROCEDURE

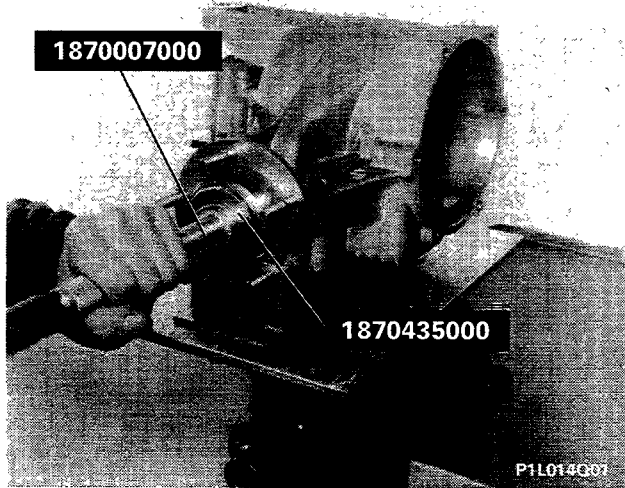

Fitting outer race of outer bevel pinion bearing

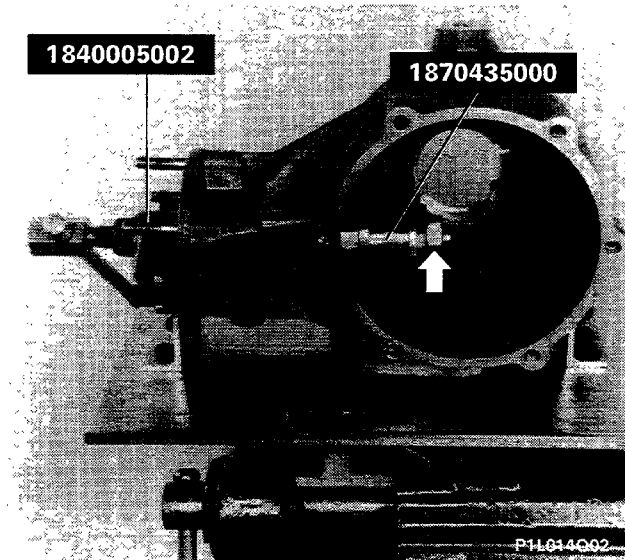

Fitting outer race of inner bevel pinion bearing

Use a service nut (shown by arrow) to obtain a thrust reaction during installation as shown in diagram.



*Before installing, check that outer race is properly positioned in its seat.*

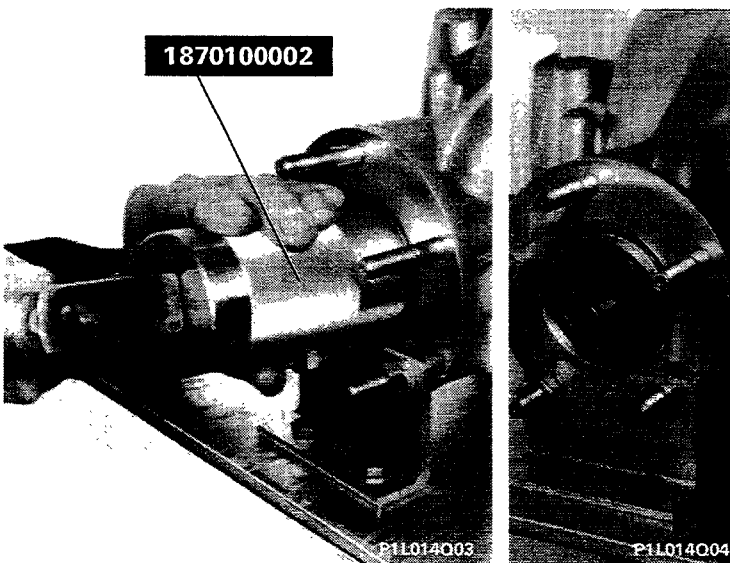

Fitting bevel pinion oil seal



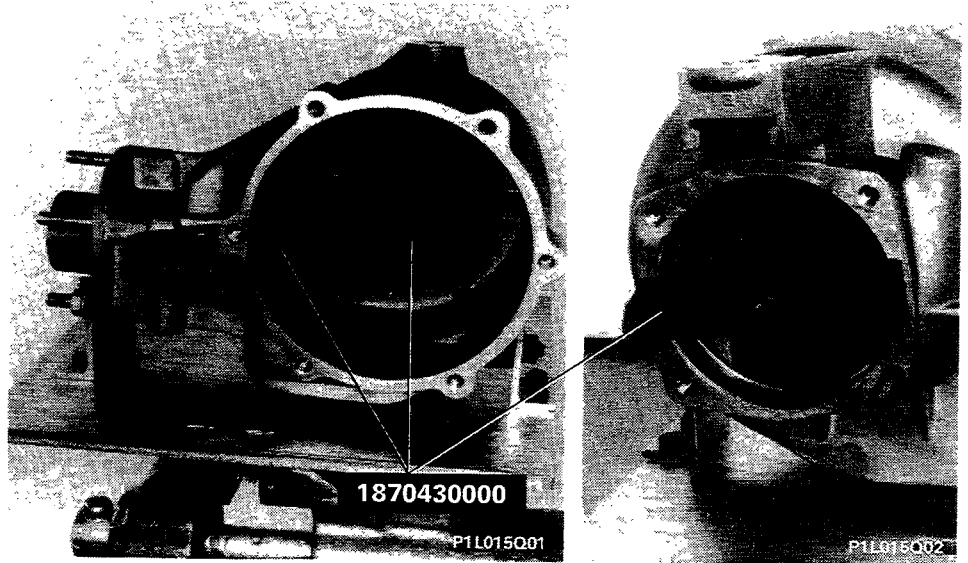

Fitting tool 1870430000  
in differential casing

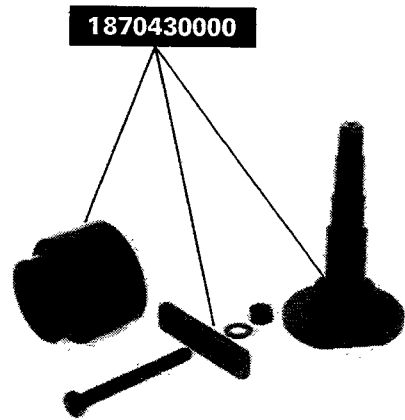

To fit dummy pinion 1870430000 proceed as for installation of bevel pinion, except miss out compressible spacer between front and rear bearings.

Tighten nut complete with flat washer to secure tool, adjust bearings and fully tighten.

P1L015Q03



Measurements for calculation of thrust ring  
thickness for rear bevel pinion bearing

To measure thrust ring thickness, use tool 189511300 as shown in the diagram.

## 27.

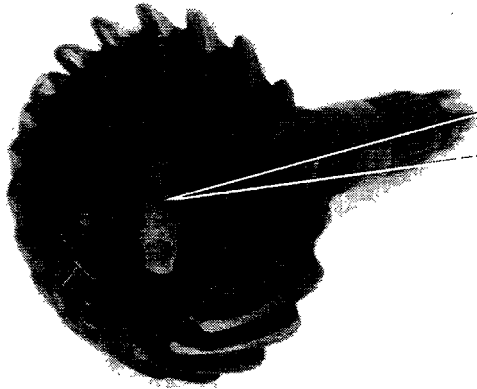

### Bevel pinion

1st case - Difference between nominal and actual fitting clearance in hundredths of a millimetre.

(examples: -2, 0, +3)

2nd case - Actual fitting clearance in millimetres.

(examples: 80.45 - 80.5 - 80.52).

You will always obtain value expressed in first case by subtracting 80.50 mm from this measurement.

(examples: 80.45 - 80.50 = - 0.05 mm = - 5 hundredths)

(80.52 - 80.50 = + 0.02 mm = + 2 hundredths).

P1L016Q02

## PROCEDURE FOR CALCULATING THICKNESS OF REAR BEARING THRUST RING ON BEVEL PINION

If "a" is value measured with tool 1895113000 and "b" is the value stamped on the bevel pinion by the Factory, then thickness "S" of thrust ring to be fitted is given by the following equation:

$$S = a - (+ b) = a - b$$

$$S = a - (- b) = a + b$$

in other words:

- if the number stamped on the pinion is preceded by a (+) sign, ring thickness is obtained by subtracting stamped number from value measured with tool 1895113000;

- if the number marked on the pinion is preceded by a (-) sign, ring thickness is obtained by adding the number to the value obtained with tool 1895113000.

Example: let a = 2.90 (value measured with tool 1895113000)

and let b = - 5 (amount in 100ths of a mm stamped on pinion);

then:  $S = a - (- b)$ ;

$$S = 2.90 - (- 0.05);$$

$$S = 2.90 + 0.05;$$

$$S = 2.95$$

In this case a thrust ring 2.95 mm thick must be added.



*If the value obtained does not correspond to one of the spare thrust rings provided, fit the next size up.*

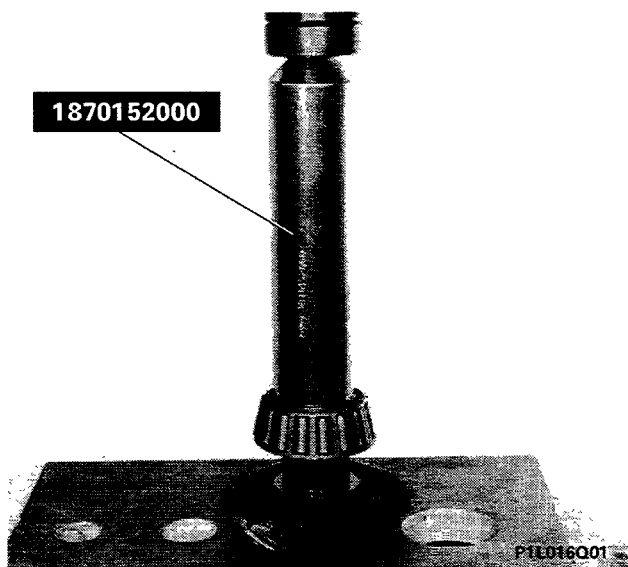

Fitting roller bearing inner race to bevel pinion using hydraulic press.

CROWN WHEEL ROLLING TORQUE

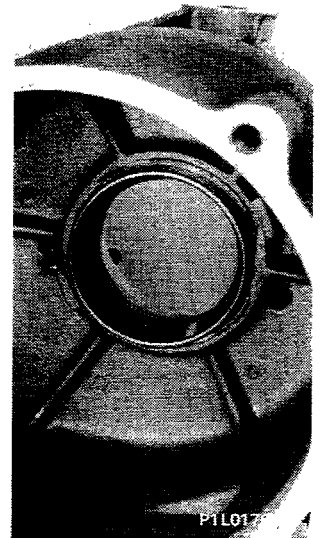
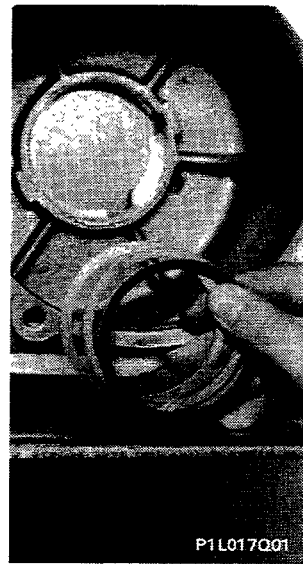

Fitting shims and differential casing bearing outer race

**NOTE** Shim thickness may be increased or decreased until differential casing bearing rolling torque is as specified.



Fitting "Torsen" differential in the casing and left cover

0,12 ÷ 0,15 daNm



P1L017Q05



1870443000

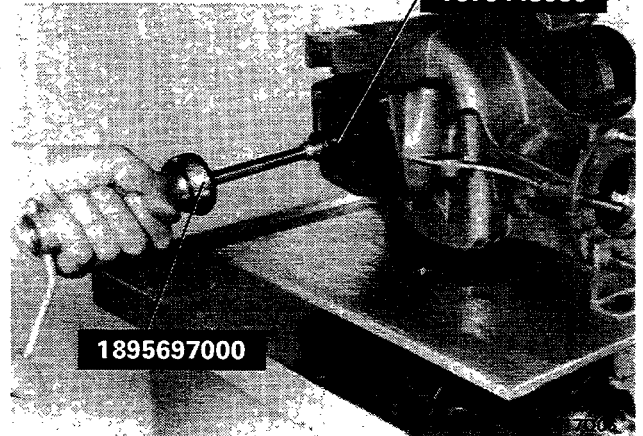

Crown wheel rolling torque

If the rolling torque is too high, decrease shim thickness. Otherwise increase thickness. Then remove differential unit.



27.

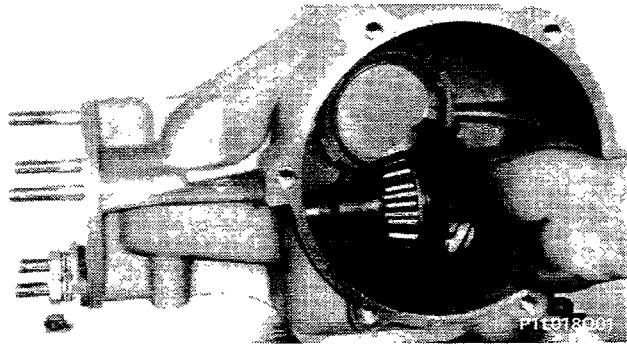

## BEVEL PINION ROLLING TORQUE

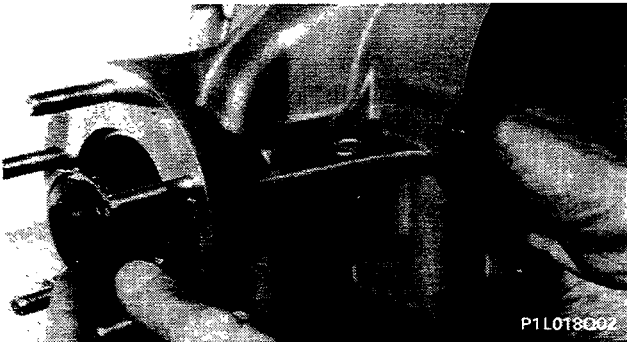

Fitting bevel pinion complete with compressible spacer and sleeve side roller bearing inner race

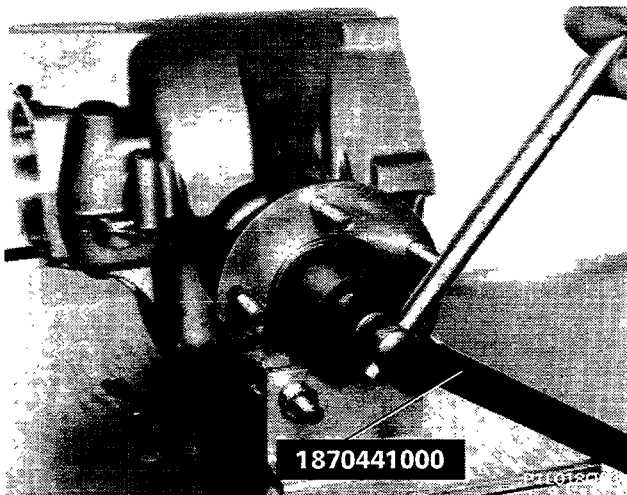

## Tightening sleeve retaining nut to bevel pinion

Nut must be tightened to a torque of 17 - 28 daNm to produce a rolling torque of 0.08-0.12 at the pinion.

With this type of differential fitted with a compressible spacer, note that bevel pinion retaining nut must never be slackeden during assembly or the spacer will have to be replaced.

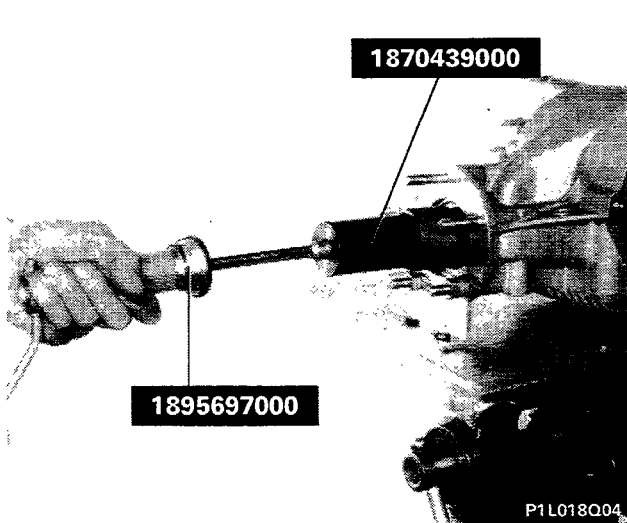

$0,08 \div 0,12 \text{ daNm}$

## Check bevel pinion rolling torque

If maximum bevel pinion rolling torque is exceeded during preloading, assembly and checks must be carried out again using a new spacer.

CHECKING PINION - CROWN  
WHEEL BACKLASH

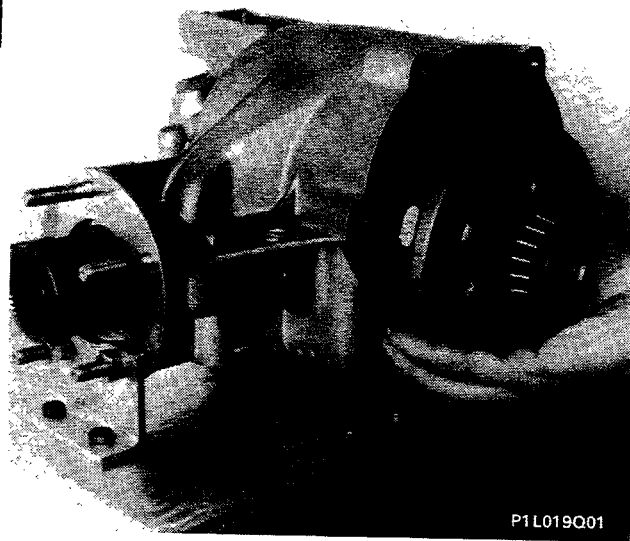

Fitting "Torsen" differential unit in casing

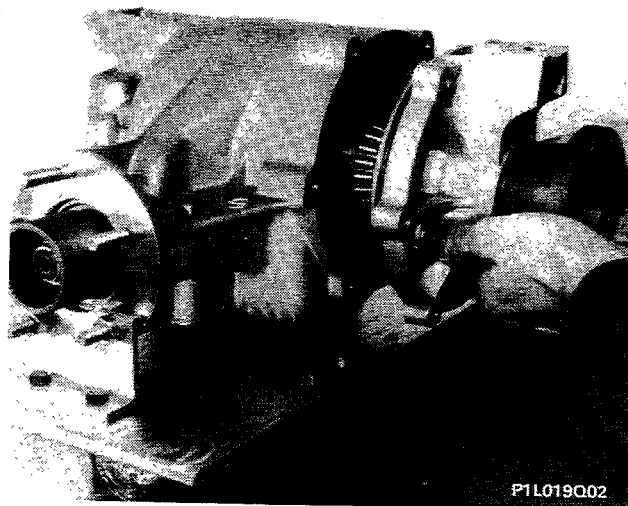

Fitting left cover on differential casing

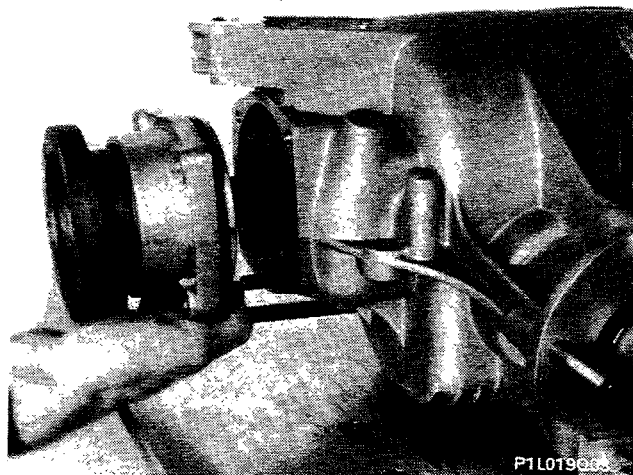

Fitting right cover on differential housing

27.

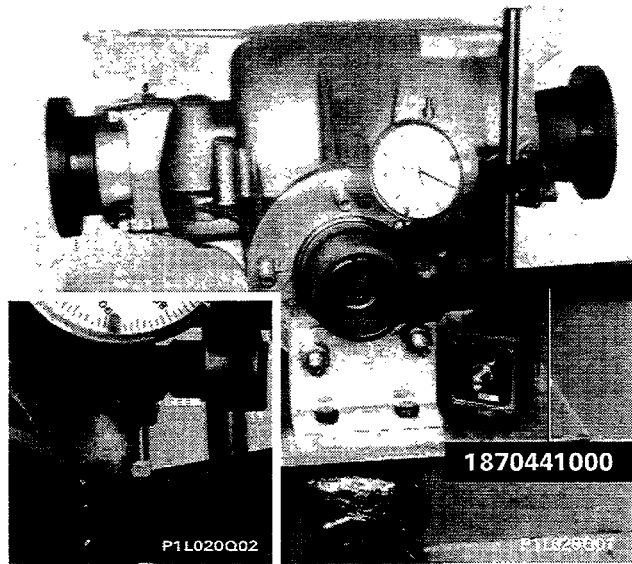

### Checking and adjusting pinion backlash

If backlash is less than or greater than specified, the crown wheel must be moved closer to or further away from the pinion by adjusting shim thickness, taking care to maintain overall value calculated during adjustment of crown wheel rolling torque.

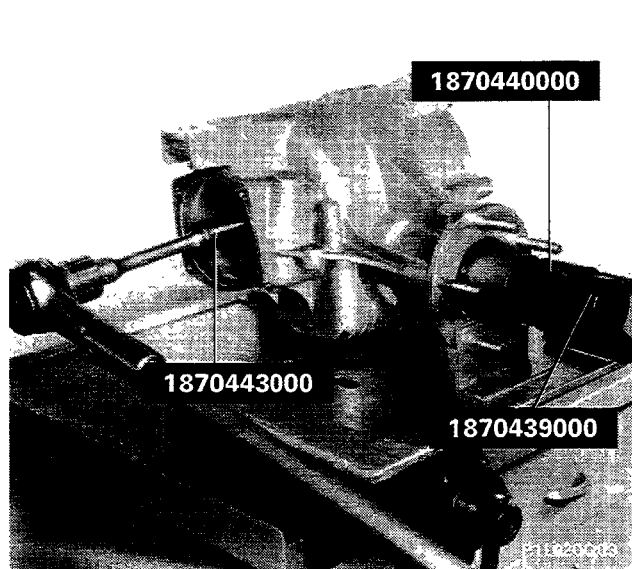

### CHECKING AND ADJUSTING BEVEL PINION AND CROWN WHEEL TOOTH CONTACT PATTERN

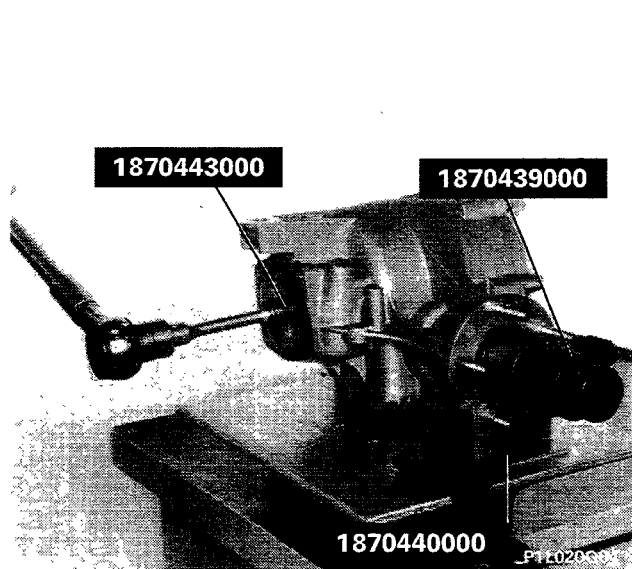

Checking contact pattern of pinion-crown wheel teeth on drive and coast sides



### Correct mesh

The contact pattern must be uniformly distributed over both tooth faces, i.e. drive and coast.

DRIVE SIDE

COAST SIDE

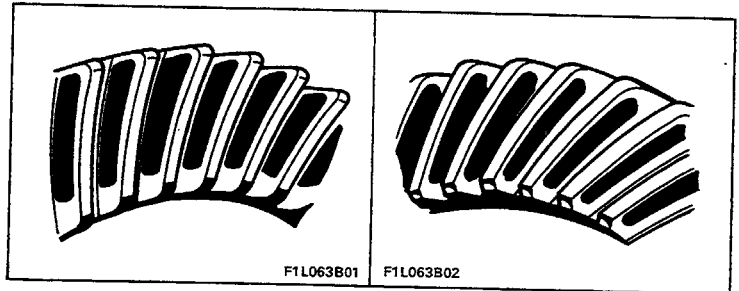

### Incorrect mesh

**Drive side:** contact on toe of tooth and towards centre.

**Coast side:** contact of heel of tooth and towards centre.

Move pinion out of mesh using thinner thrust ring

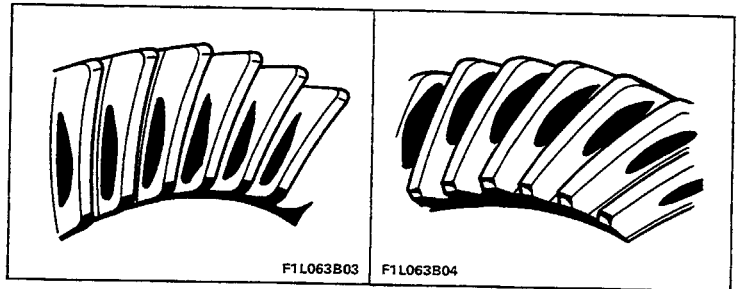

### Incorrect mesh

**Drive side:** toe contact, localised at root.

**Coast side:** heel contact, localised at root.

Move pinion out of mesh using thinner thrust ring.

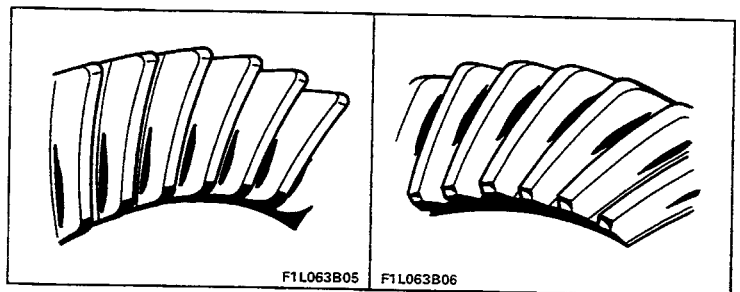

### Incorrect contact

**Drive side:** contact at heel and towards centre of tooth.

**Release side:** contact at toe and towards centre of tooth.

Move pinion into mesh, using thicker thrust ring.

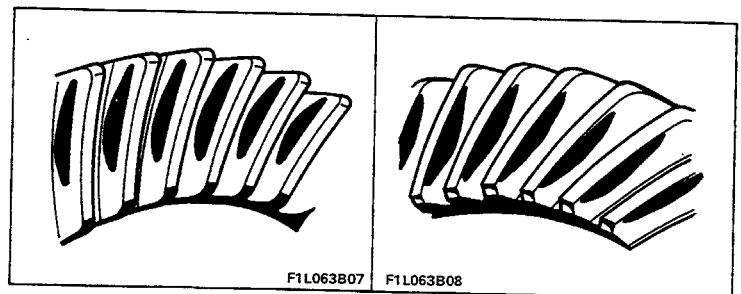

### Incorrect contact

**Drive side:** Heel contact, localised on crest of tooth.

**Coast side:** Toe contact, localised on crest of tooth.

Move pinion into mesh, using thicker thrust ring.

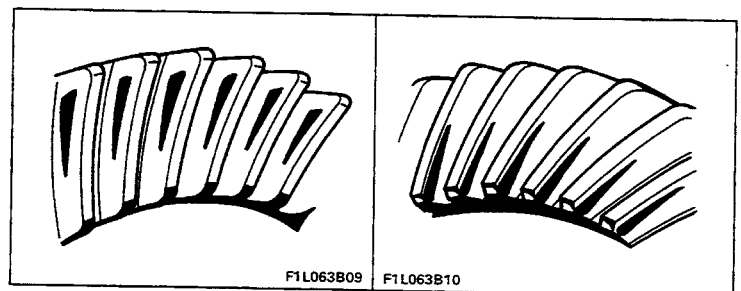

*In all above cases, unit must be removed. When refitting, repeat pinion-crownwheel backlash adjustment.*

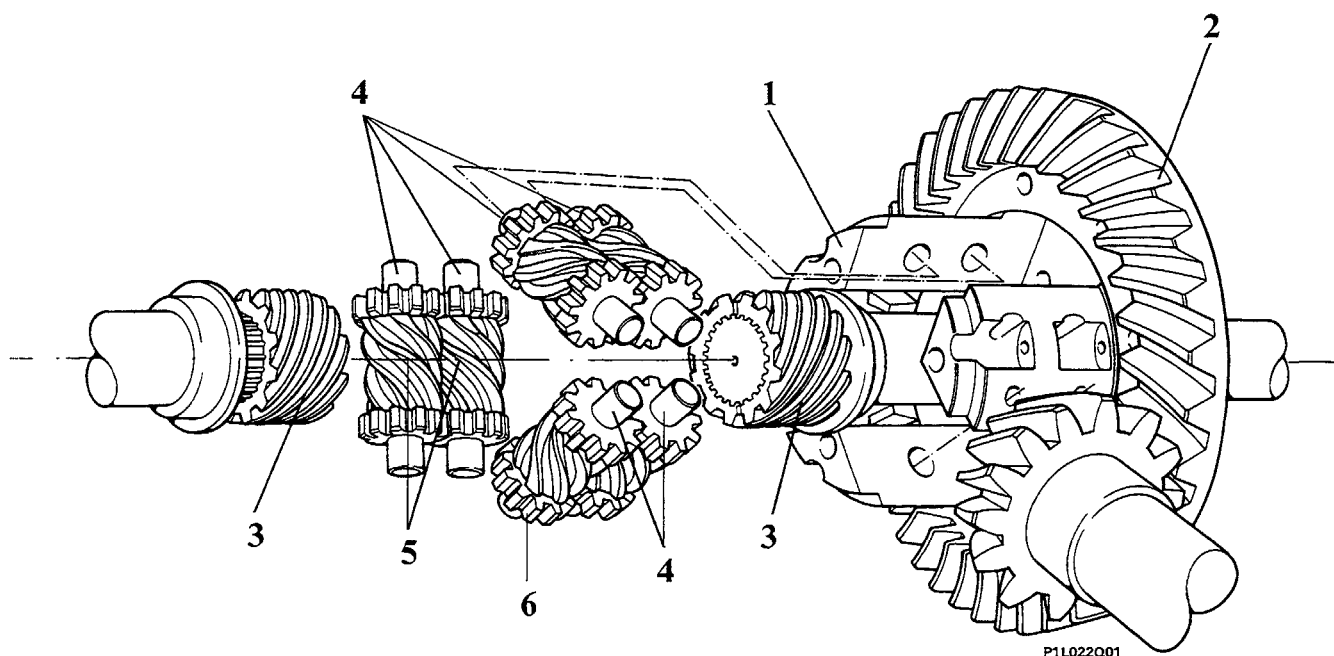

### General

The differential unit consists of a casing with covers fixed to the rear crossbeam via rubber blocks.

The casing contains: a pinion-crownwheel unit, "Torsen" differential casing plus thrust rings and shims to ensure proper unit operation.

All internal casing components can be overhauled and are therefore supplied as spares. The casing cannot be overhauled and should therefore be replaced if defective.

The "Torsen" differential is designed to prevent skidding if one wheel slides and causes the wheels to turn at different speeds.

This new system could be described as a "geared computer" that strictly meters the amount of torque to be transmitted to each wheel. At the point of skidding, therefore, wheel grip on the road will be low and the wheel will receive less torque.

The "Torsen" unit consists of:

- outer casing (1) that receives drive from the propeller shaft through a crownwheel (2);
- two planet wheels (3) consisting of worm screws, one connected to the right wheel and one to the left wheel;
- three pairs of satellites (4) consisting of helical gears (5) pivoted on outer casing and meshed with planet wheels, and linked spur gears (6).

The "Torsen" unit is maintenance free. During service operations, the unit may be completely replaced or the bevel gear set and bearings may be replaced.

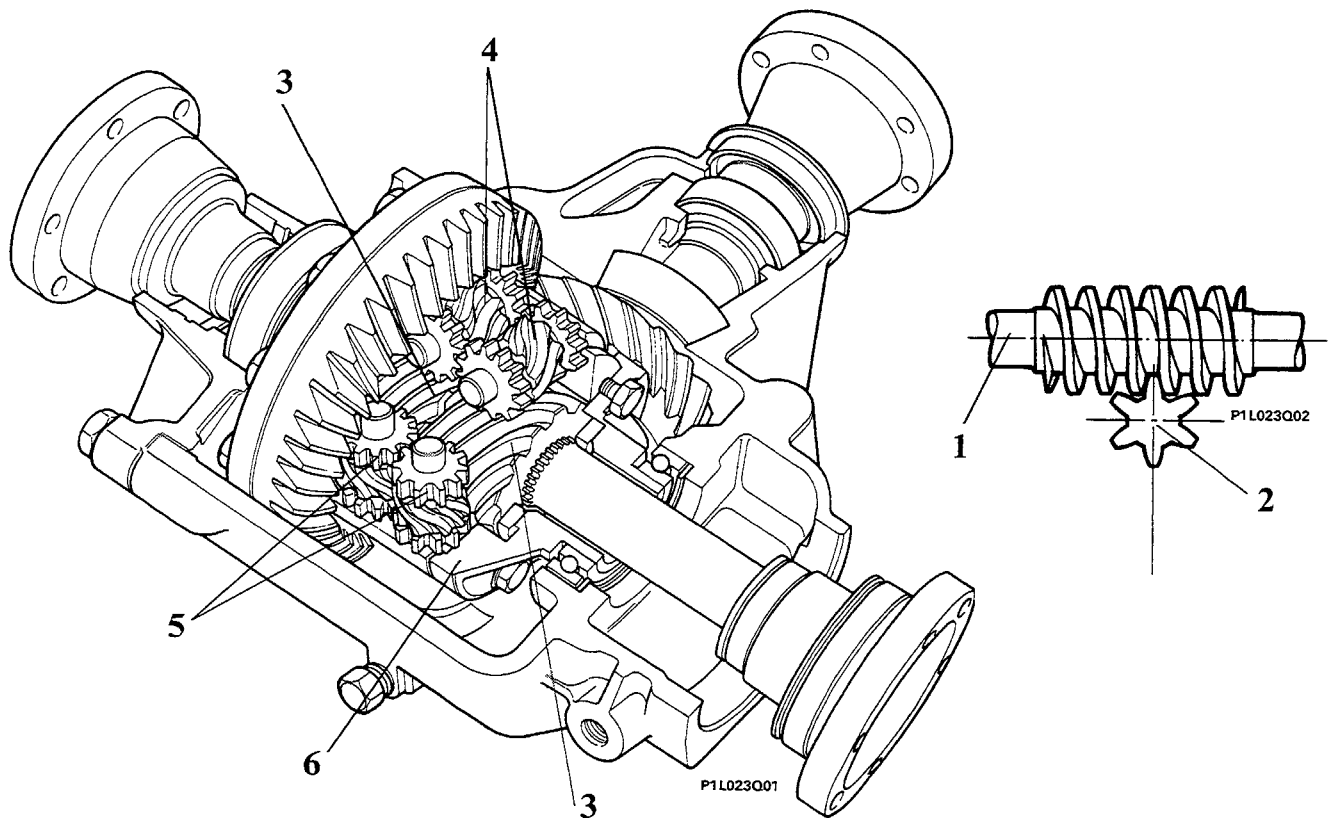

### Operation

"Torsen" unit operation is based on a worm gear set. This type of drive can allow, under certain conditions (choice of material-tooth angle), drive in a single direction. The worm screw (1) can turn gear (2) with which it meshes whereas the gear cannot turn the worm screw.

In the "Torsen" unit, the worm screws (3) are connected to the drive shafts and face one another. The three pairs of helical gears (4) mesh with the screws. They also mesh with one another via link gears (5) and are pivoted on the differential casing (6).

The main feature of Torsen system operation is, as already mentioned, the irreversibility of the worm gear set. Total irreversibility is obtained when the thrust angle between worm screw teeth and helical gear approaches  $90^\circ$ . This represents 100% locking, i.e. complete prevention of escape due to loss of grip. An angle of nearly  $90^\circ$  actually poses two problems:

- rough operation;
- bad differentiation on bends: the thrust exercised by the helical gear on the worm screw would mainly be discharged to the steering system to generate considerable friction.

For good cornering differentiation and good lock, the angle must be moderated. Torsen system currently available have torque ratios between one drive shaft and the other of between 4 : 1 and 7 : 1, i.e. one wheel may receive a torque 4-7 times greater than the other. Expressed in percentage terms, the 4 : 1 and 7 : 1 torque ratios represent a locking percentage of 60-80%. In a Torsen differential, the transfer of torque from one half shaft to another is totally independent of the differential action; this permits safe driving in all situations and takes place in a completely automatic, uniform manner.



27.

DIAGRAM OF REAR DIFFERENTIAL LOCK UNIT

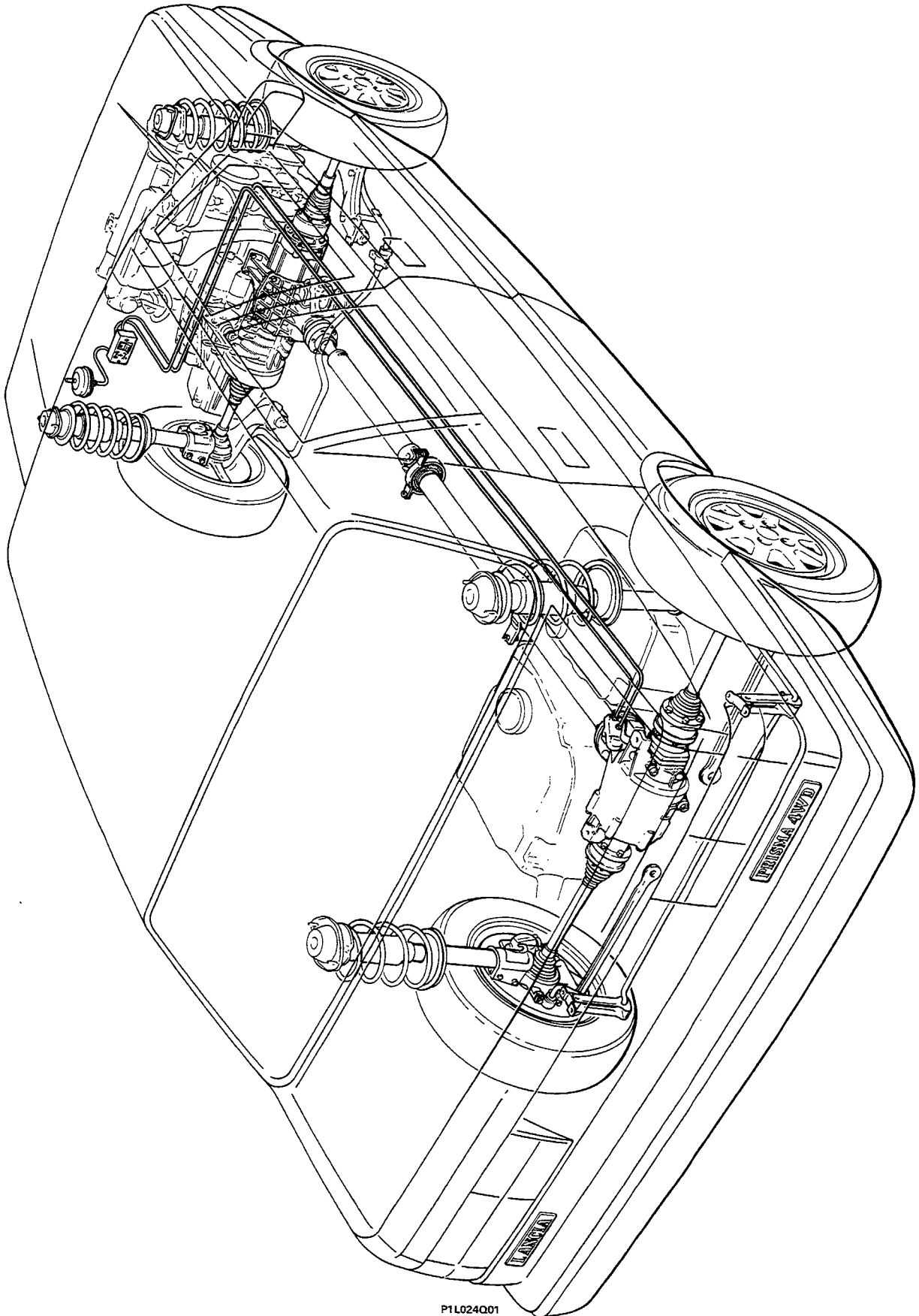

P1L024Q01

**PROCEDURE**

Position differential unit on stand 18704360 fixed in clamp for overhaul; then proceed as follows:

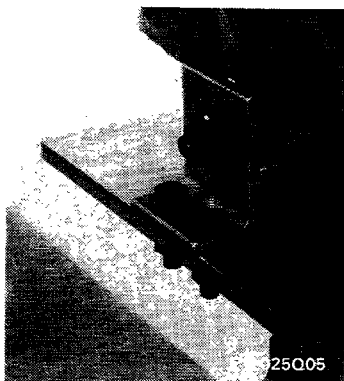
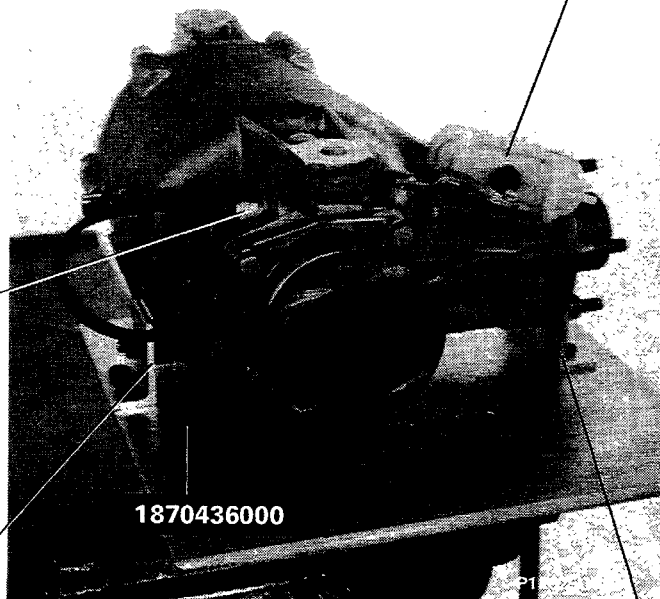
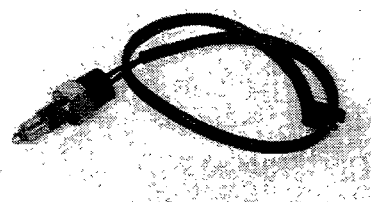
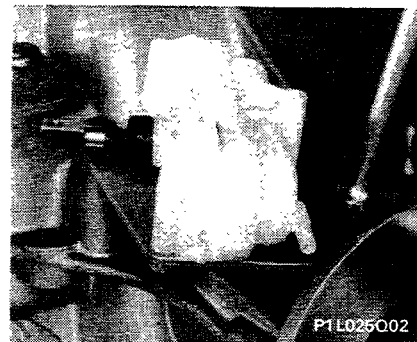
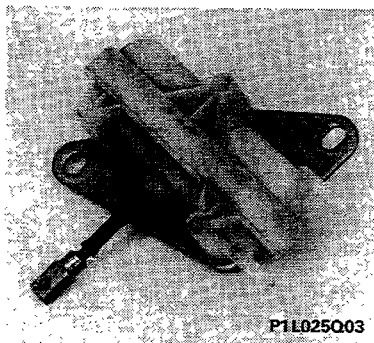

Points for fastening differential unit to  
overhaul stand 1870436000

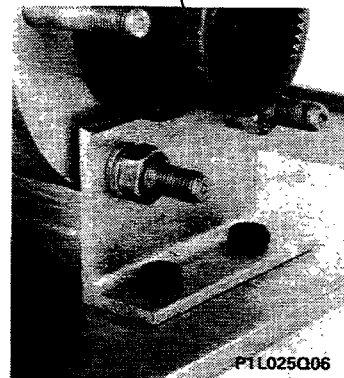

27.

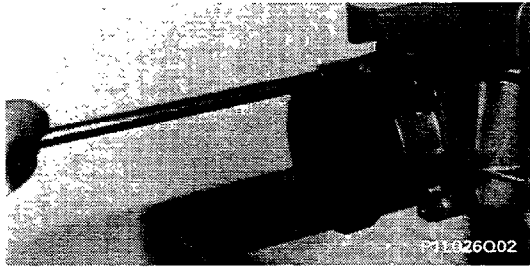
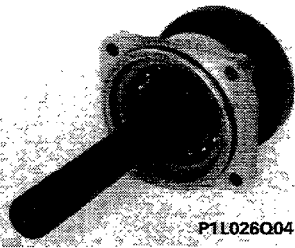
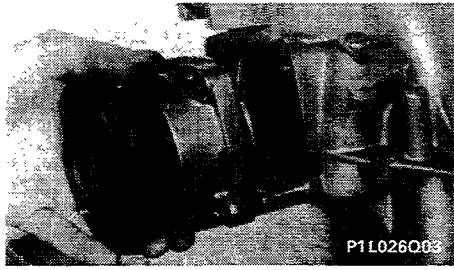

Remove right differential casing cover

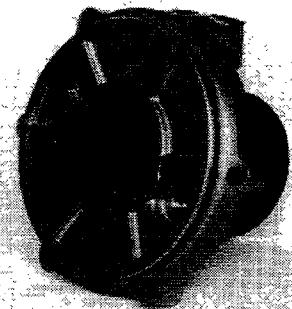
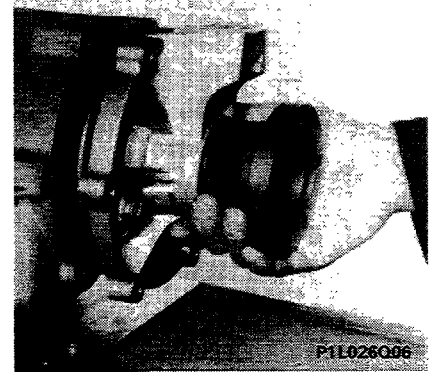
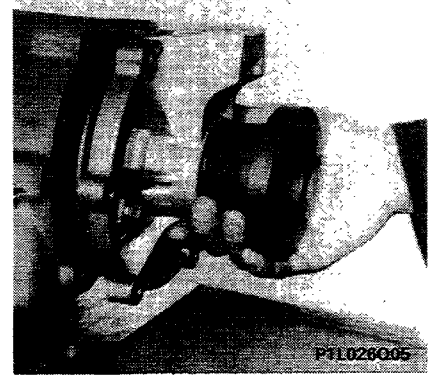
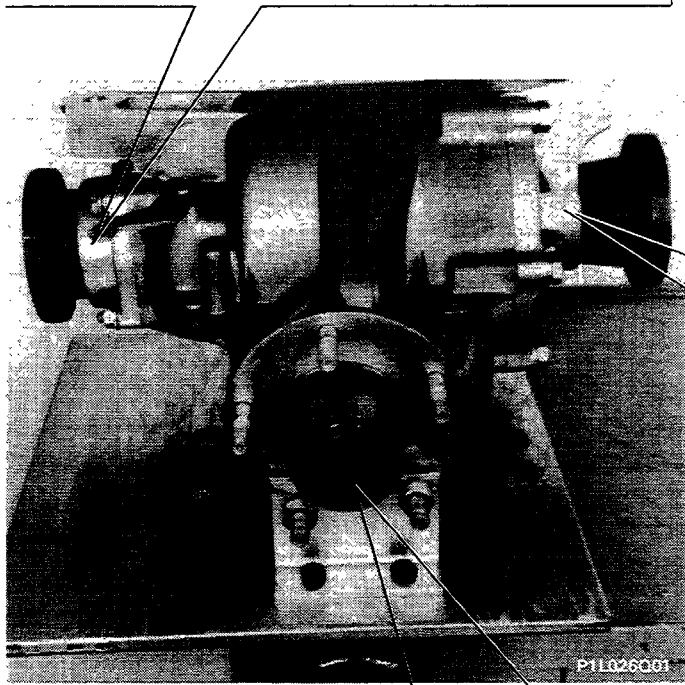

Remove left differential casing cover

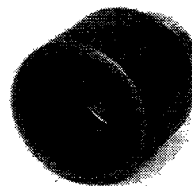
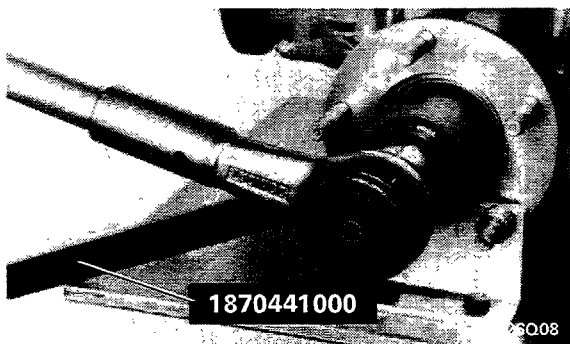

Remove bevel pinion sleeve



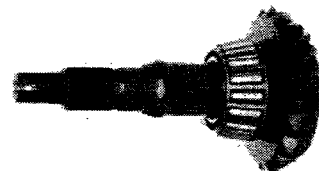
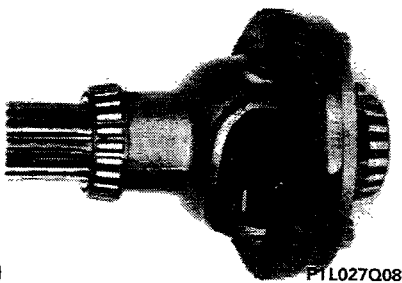
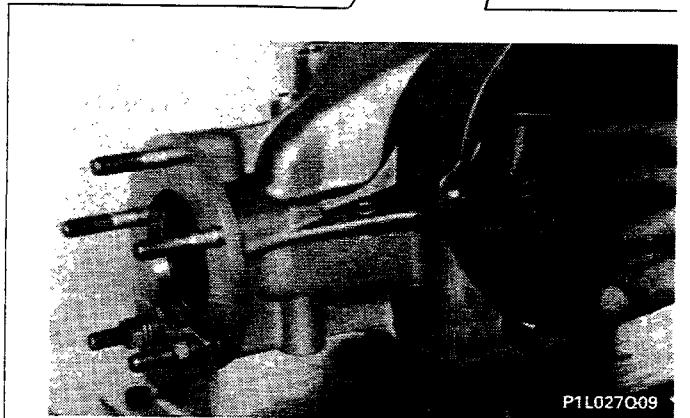
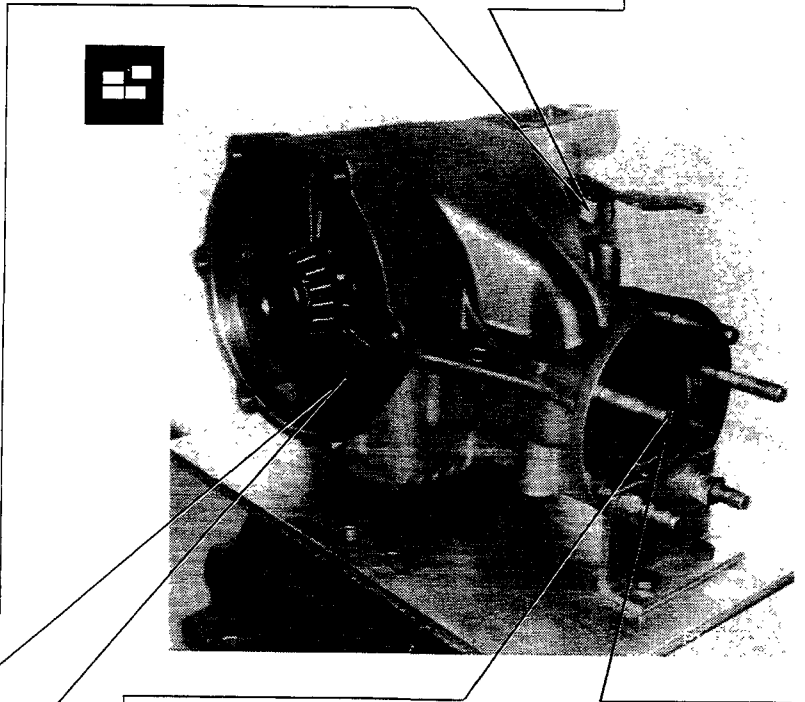
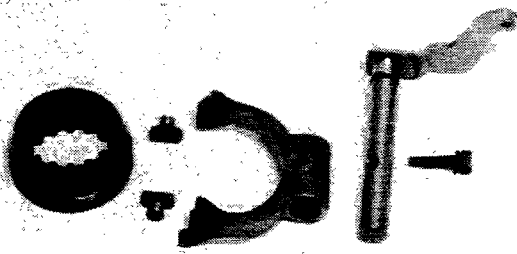
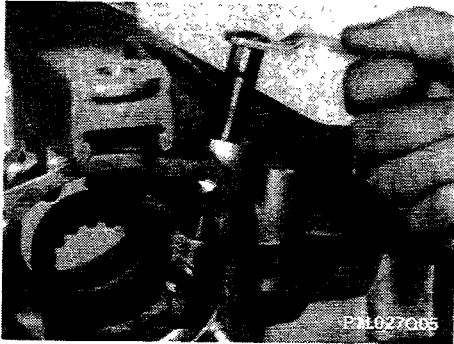
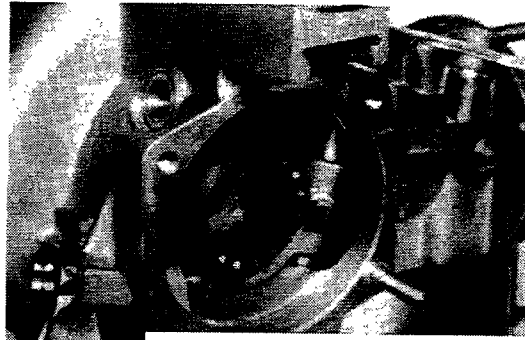
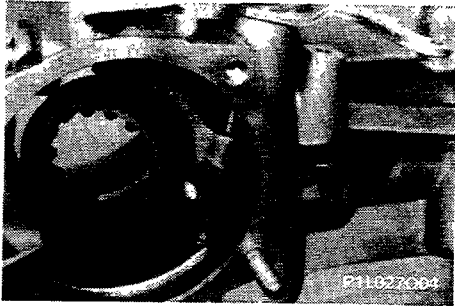

27.

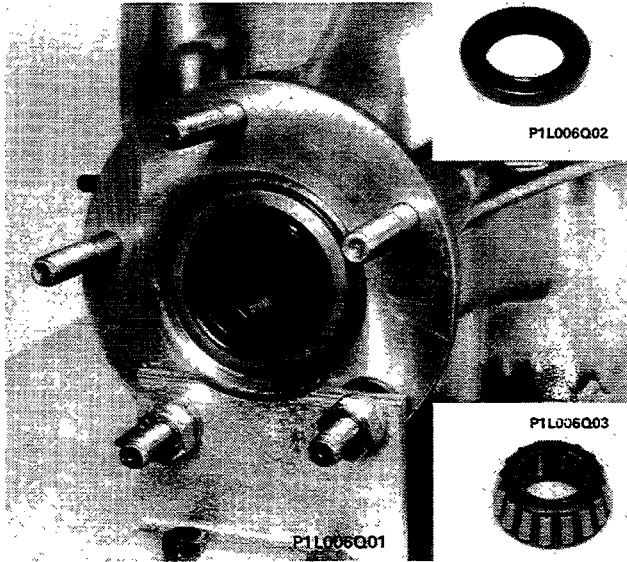

Removing differential pinion gasket and bearing

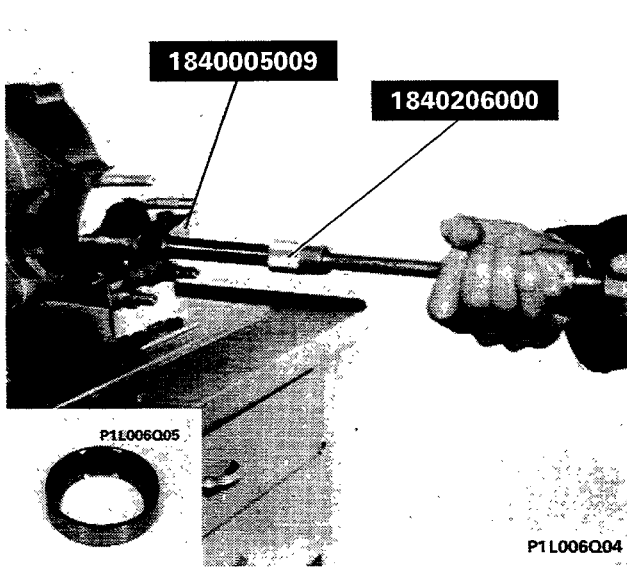

Removing outer differential pinion bearing race

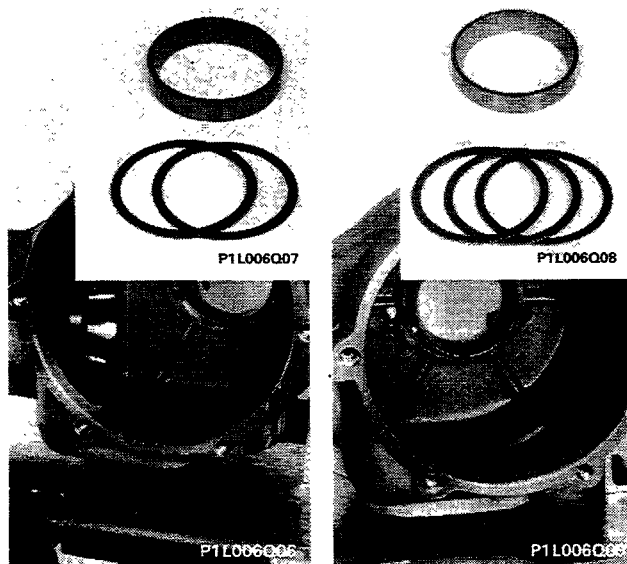

Removing bearing outer races with shims for pinion and crownwheel

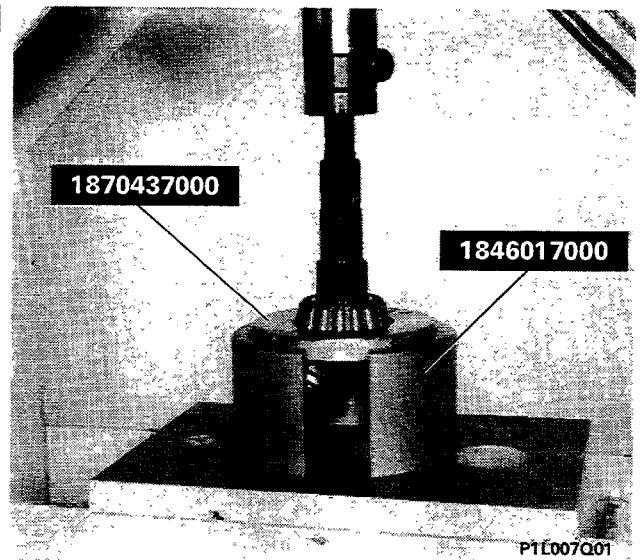

P1L007Q01

Removing rear pinion bearing inner race using hydraulic press

**LEFT DIFFERENTIAL CASING COVER**

Removing-refitting and checks

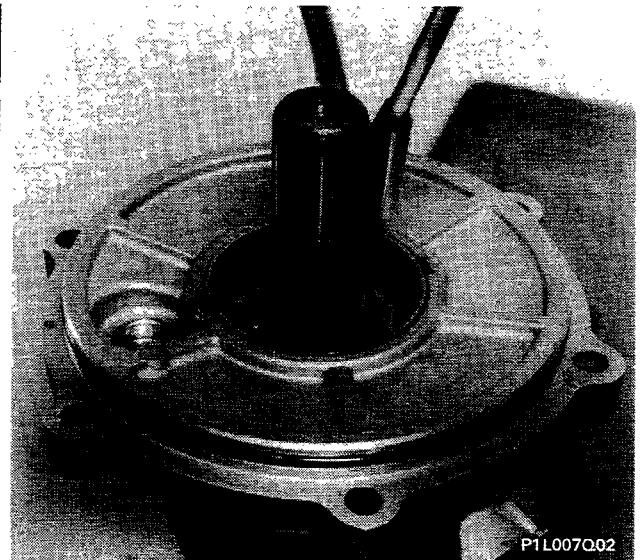

P1L007Q02

Removing-refitting drive shaft sealing ring to cover

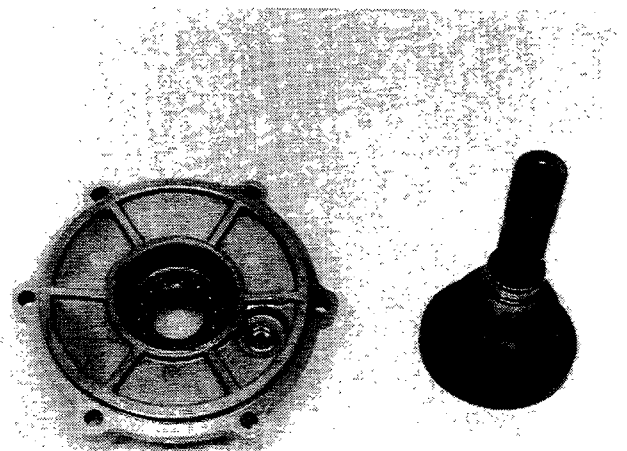

View of left cover separated from drive shaft

**NOTE** Check that drive shaft is not distorted and that surfaces and splines are not damaged. Replace if necessary.

P1L007Q03

### 27.

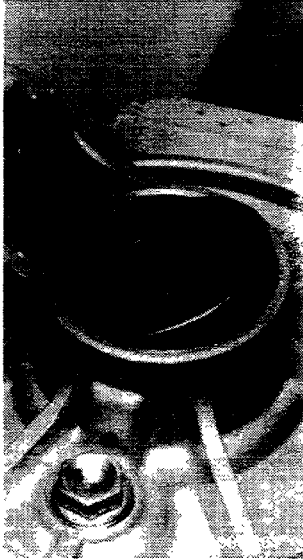

#### Removing-refitting left drive shaft seal

To fit seal, use tool 1870100002 as shown in diagram.

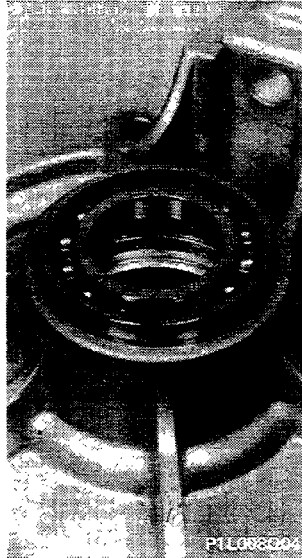
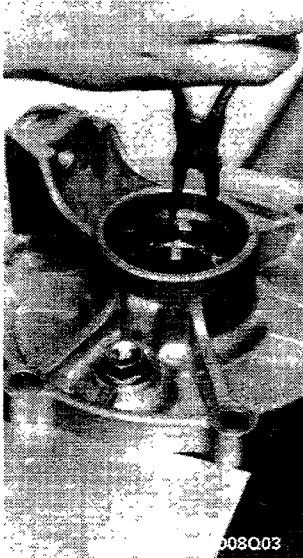

#### Removing-refitting retaining ring and left drive shaft ball bearing

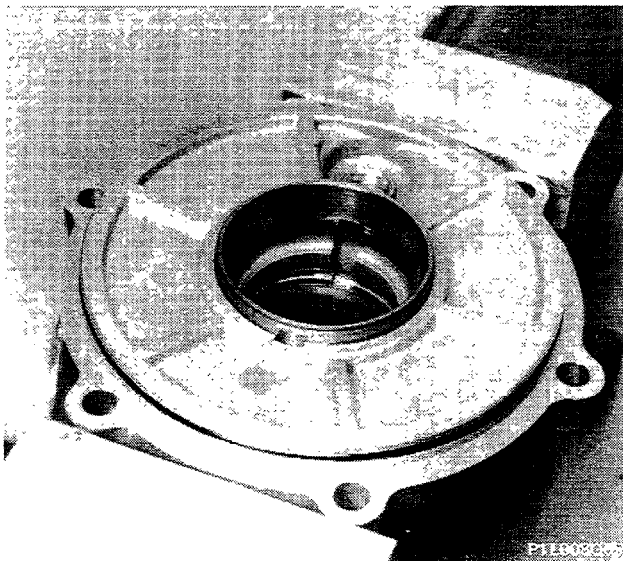

#### Removing-refitting outer ball bearing race for "Torsen" differential



**RIGHT DIFFERENTIAL CASING COVER**

Removing-refitting and checks

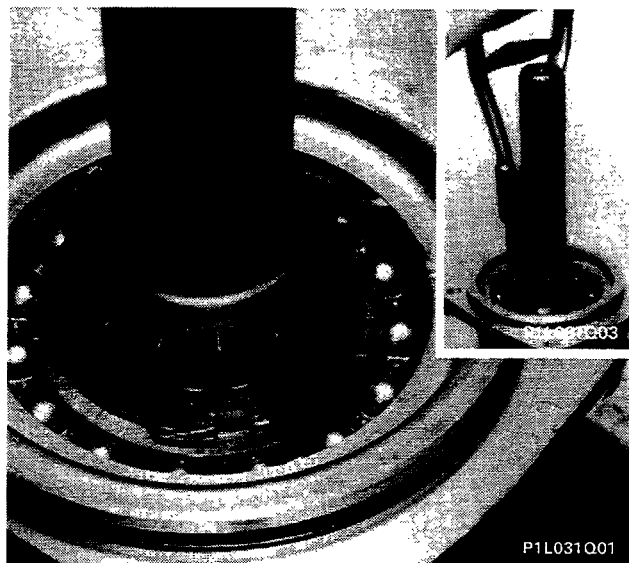

P1L031Q01

**Removing right drive shaft retaining ring**

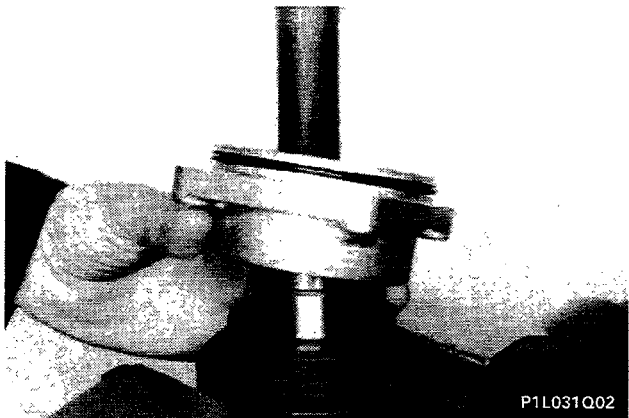

P1L031Q02

**Removing right cover from drive shaft**

**NOTE** Check that drive shaft is not distorted and that surfaces and splines are not damaged. Replace if necessary.

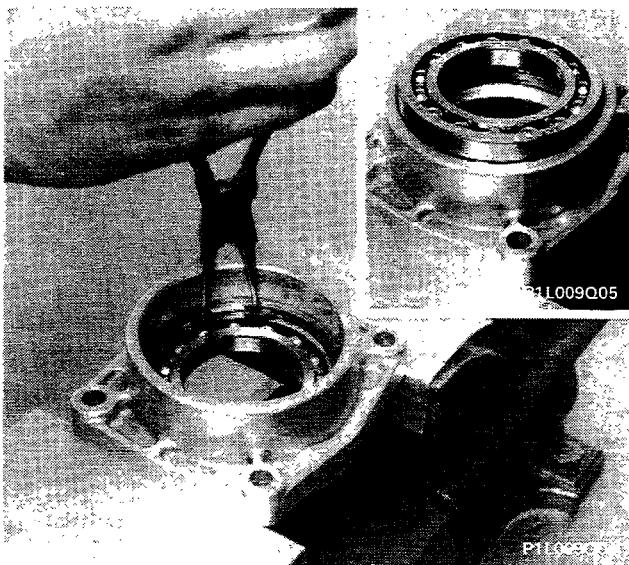

P1L009Q05

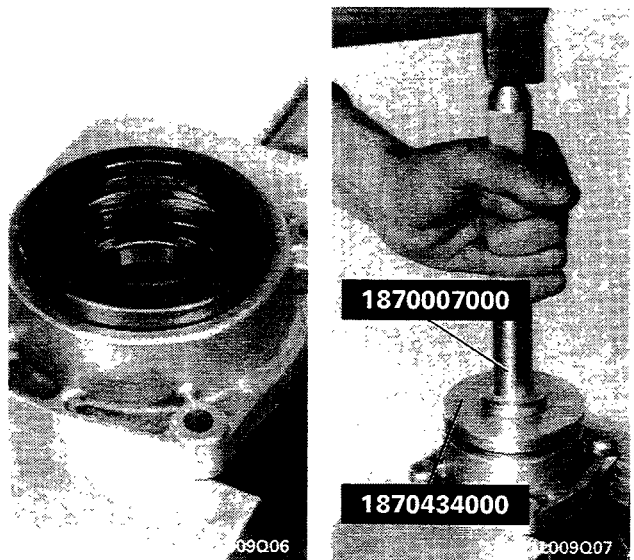

1870007000

1870434000

P1L009Q07

**Removing-refitting retaining ring and right drive shaft ball bearing**

**Fitting right drive shaft seal**

27.

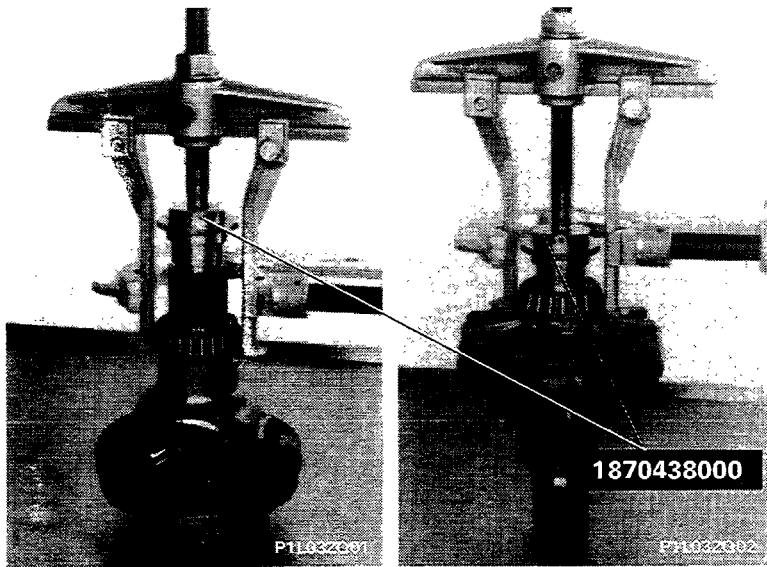

**DIFFERENTIAL UNIT**  
Removing-refitting and checks

**Removing roller bearings from differential casing**

Bearings should be replaced if they show signs of scoring, hot spots or excessive wear.

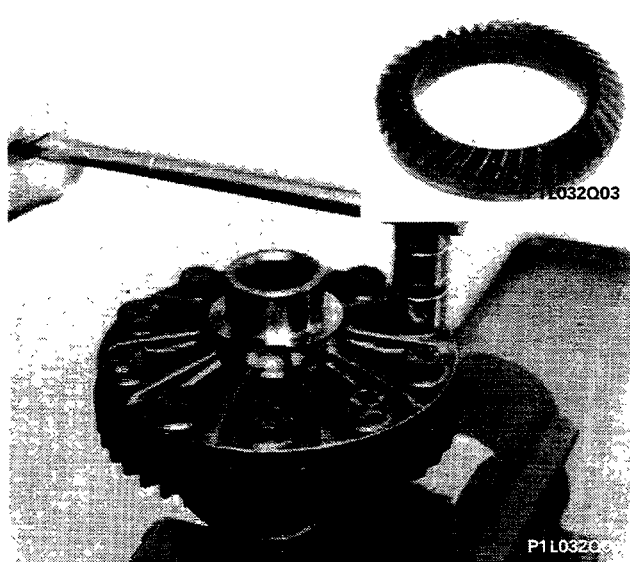

**Removing crown wheel from differential unit**

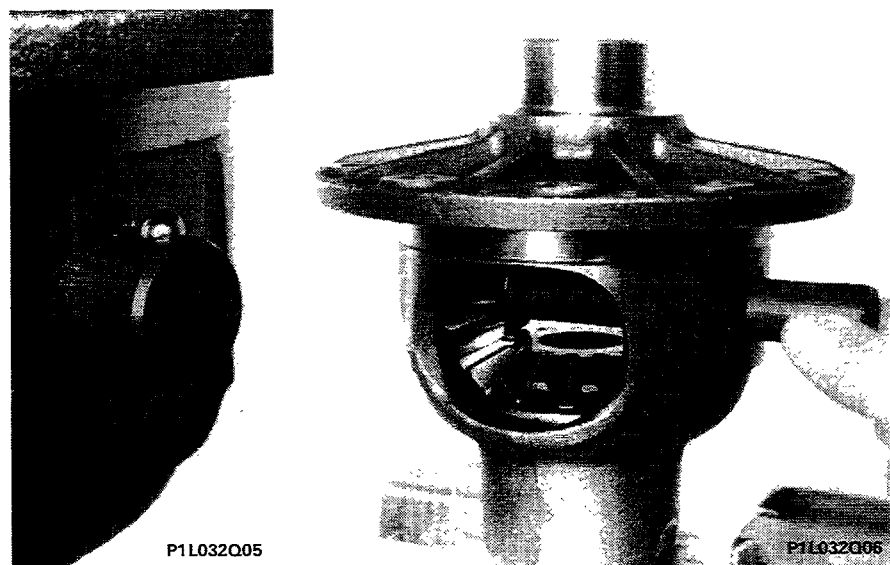

**Removing-refitting satellite carrier shaft after removing ball stop**

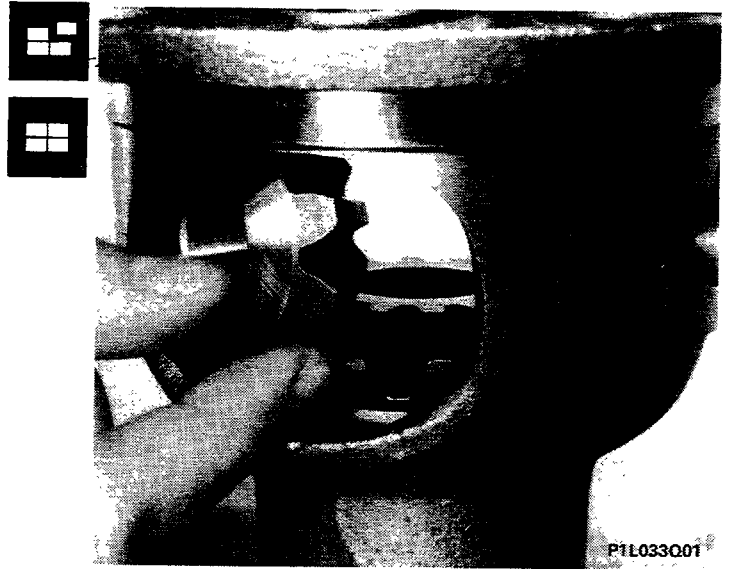

Removing-refitting satellites from differential casing



Removing-refitting planet wheels from differential casing



**Differential casing**

**NOTE** *The differential casing should not be cracked. Bearing seats should not be worn or damaged. Replace if necessary.*



27.



## PROCEDURE

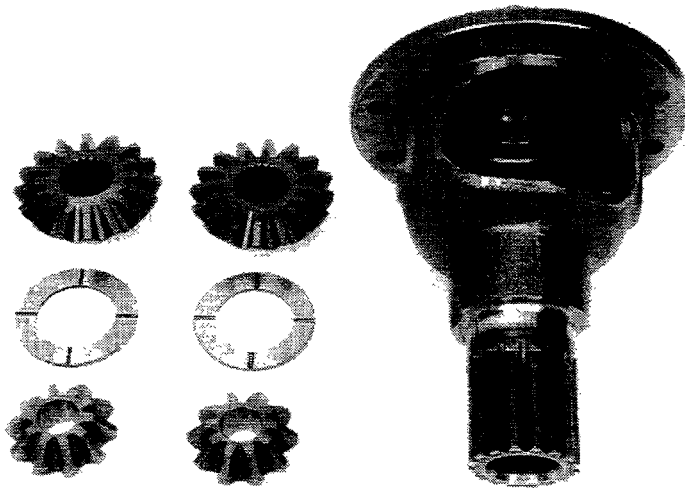

P1L034Q01

### Differential unit components

Satellite and planet gears should not show signs of wear or chipping on their working surfaces.



3,8 daNm

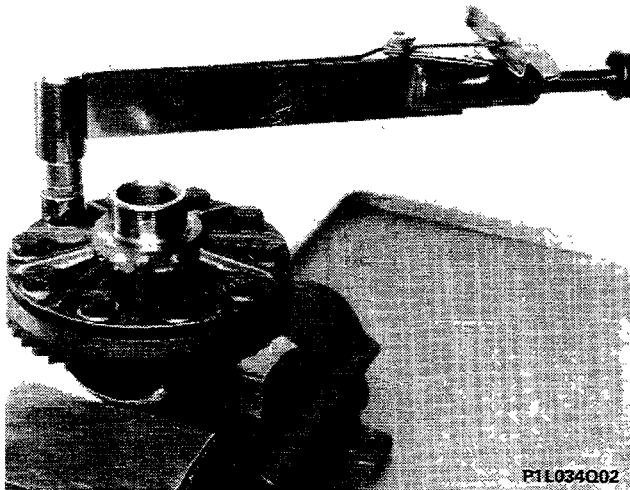

P1L034Q02

### Fitting and torque tightening of crownwheel

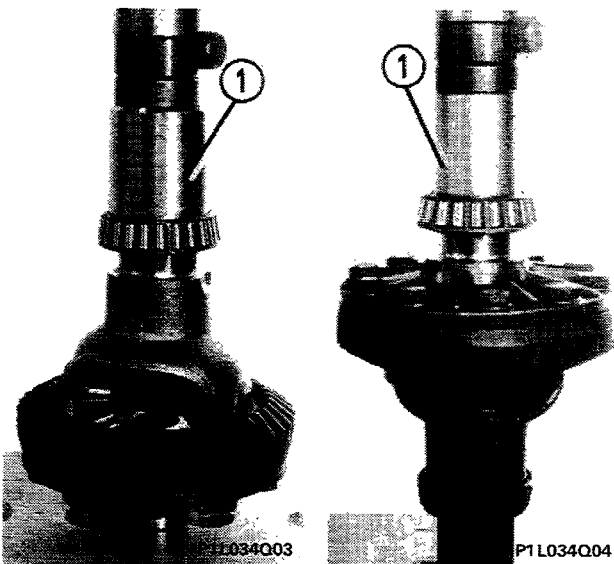

P1L034Q03

P1L034Q04

### Fitting roller bearings in differential casing using hydraulic press

1. Thrust element





Fitting outer race of outer bevel pinion bearing

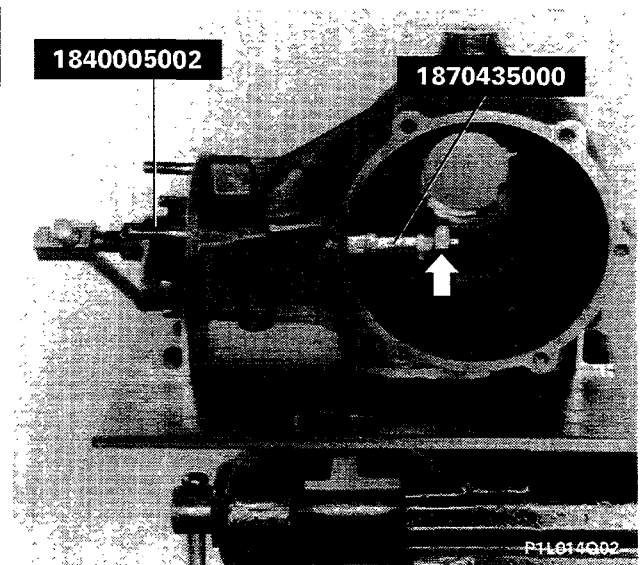

Fitting outer race of inner bevel pinion bearing

Use a service nut (shown by arrow) to obtain a thrust reaction during installation as shown in diagram.



*Before installing, check that outer race is properly positioned in its seat.*

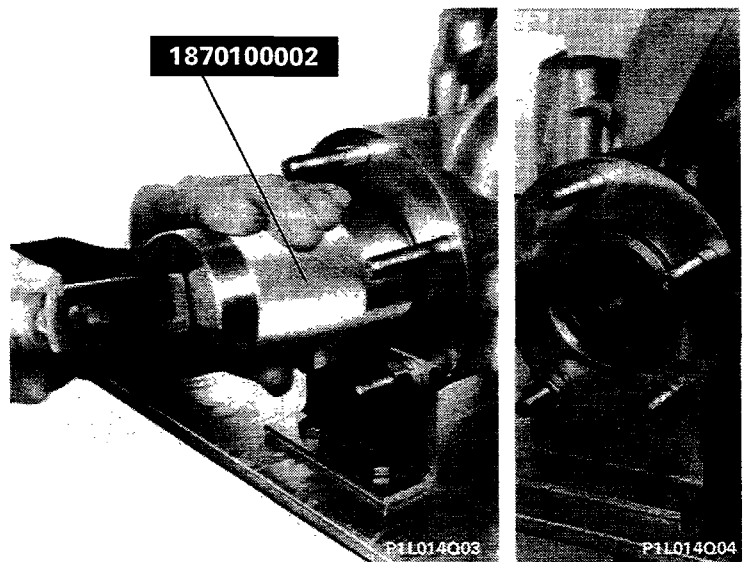

Fit bevel pinion oil seal

## 27.

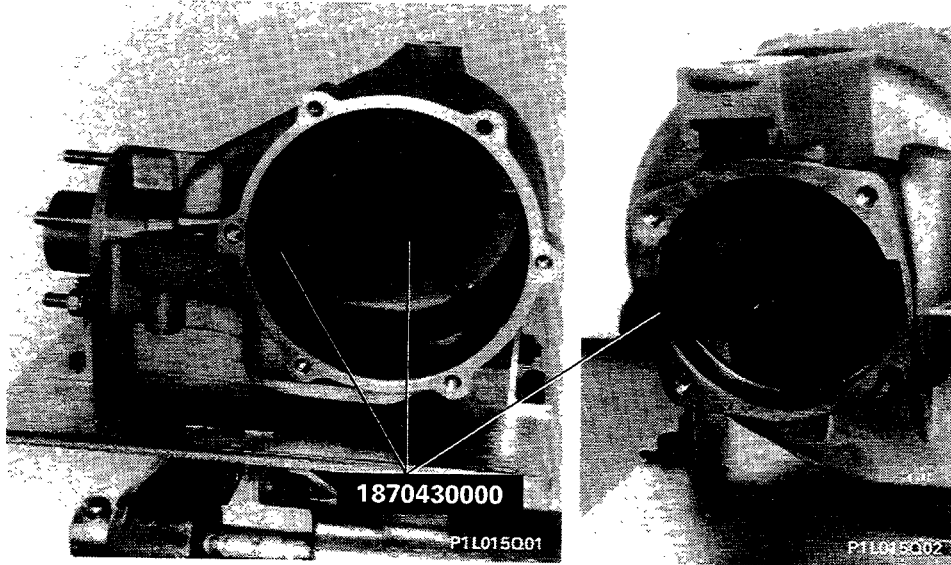

Fitting tool 1870430000  
to differential casing

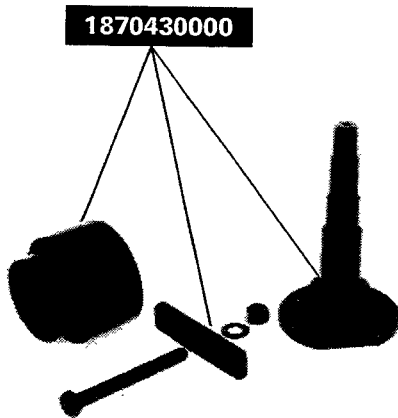

To fit dummy pinion 1870430000 proceed as for installation of bevel pinion, except miss out compressible spacer between front and rear bearings.

Tghten nut complete with flat washer to secure tool, adjust bearings and fully tighten.

P1L015Q03



Measurements for calculation of thrust ring thickness for rear bevel pinion bearing

To measure thrust ring thickness, use tool 18951130000 as shown in the diagram.

**Bevel pinion**

1st case - Difference between nominal and actual fitting clearance in hundredths of a millimetre.

(examples: -2, 0, +3)

2nd case - Actual fitting clearance in millimetres.

(examples: 80.45 - 80.5 - 80.52).

You will always obtain value expressed in first case by subtracting 80.50 mm from this measurement.

(examples: 80.45 - 80.50 = - 0.05 mm = - 5 hundredths)

(80.52 - 80.50 = + 0.02 mm = + 2 hundredths).

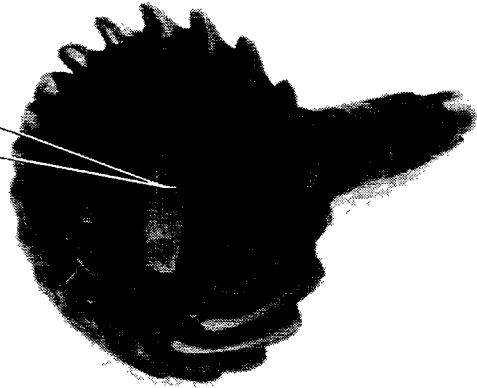

P1L016Q02

**PROCEDURE FOR CALCULATING THICKNESS OF REAR BEARING THRUST RING ON BEVEL PINION**

If "a" is value measured with tool 18951130000 and "b" is the value stamped on the bevel pinion by the Factory, then thickness "S" of thrust ring to be fitted is given by the following equation:

$$S = a - (+ b) = a - b$$

$$S = a - (- b) = a + b$$

in other words:

- if the number stamped on the pinion is preceded by a (+) sign, ring thickness is obtained by subtracting the number from value measured with tool 1895113000;
- if the number marked on the pinion is preceded by a (-) sign, ring thickness is obtained by adding the number to the value measured with tool 1895113000.

Example: let a = 2.90 (value measured with tool 1895113000)

and let b = - 5 (amount in 100ths of a mm stamped on pinion);

then:  $S = a - (- b)$ ;

$$S = 2.90 - (- 0.05);$$

$$S = 2.90 + 0.05;$$

$$S = 2.95$$

In this case a thrust ring 2.95 mm thick must be added.



*If the value obtained does not correspond to one of the spare thrust rings provided, fit the next size up.*



1870152000

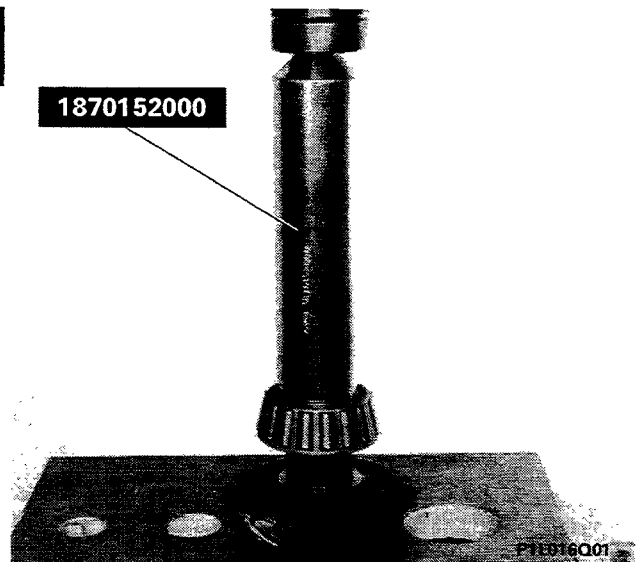

P1L016Q01

**Fitting rear roller bearing inner race to bevel pinion using hydraulic press.**

## 27.

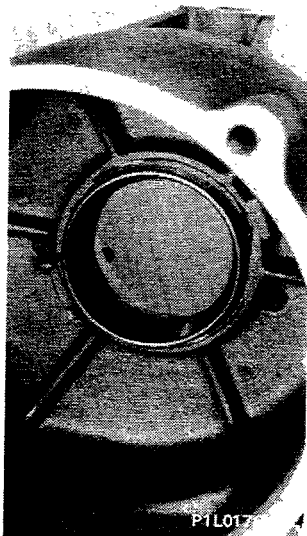
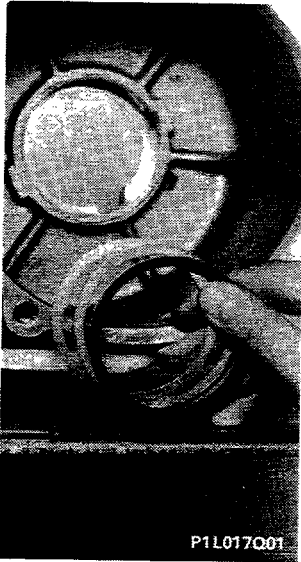

### CROWNWHEEL ROLLING TORQUE

**Fitting shims and differential casing outer race**

**NOTE** Shim thickness may be increased or decreased until differential casing bearing rolling torque is as specified.

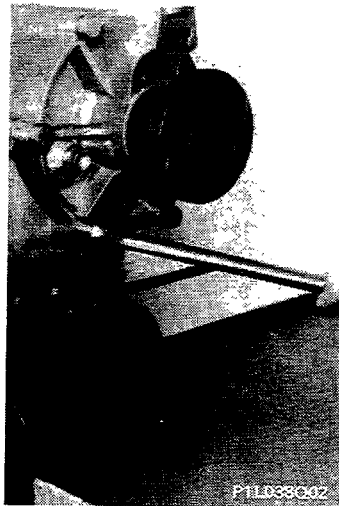

**Fitting differential unit and left cover on casing**

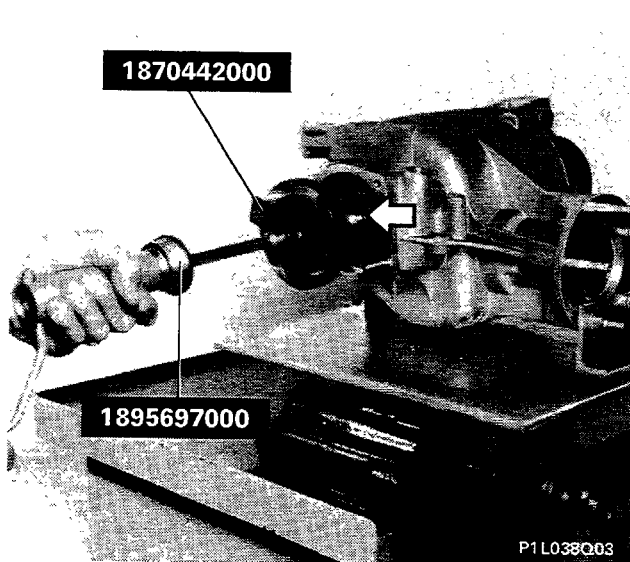

**0,12 ÷ 0,15 daNm**

### Crownwheel rolling torque

To carry out this check, fit sleeve (arrowed) to lock right drive shaft. If the rolling torque is too high, decrease shim thickness. Otherwise increase thickness.

Then remove differential unit.



### BEVEL PINION ROLLING TORQUE

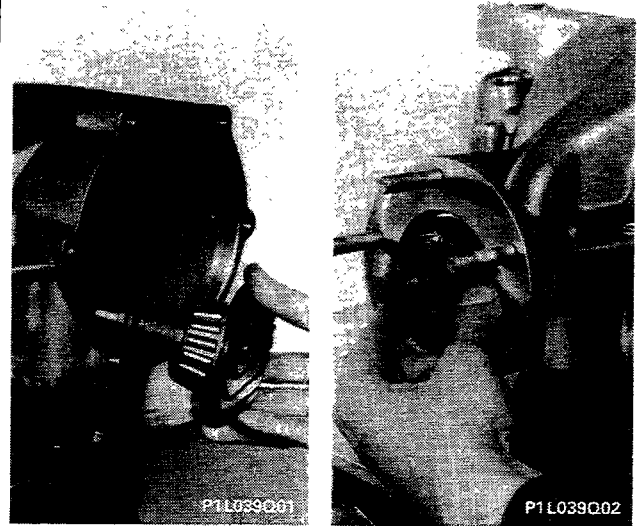

Fitting bevel pinion complete with compressible spacer and sleeve side roller bearing inner race

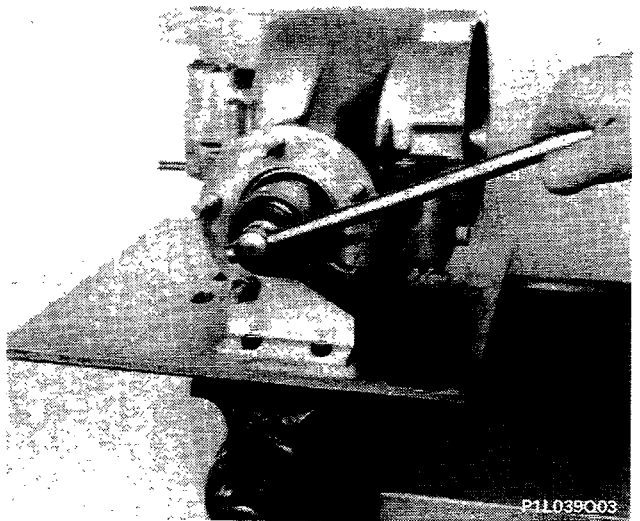

### Tightening nut retaining sleeve to bevel pinion

Tighten nut to a torque of 17 - 28 daNm in order to produce a rolling torque of 0.08-0.12 daNm at pinion.

With this type of differential fitted with a compressible spacer, note that bevel pinion retaining nut must never be slackened during assembly or the spacer will have to be replaced.

**0,08 ÷ 0,12 daNm**



**1870439000**



### Check bevel pinion rolling torque

If maximum bevel pinion rolling torque is exceeded during preloading, assembly and checks must be carried out again using a new spacer.

27.

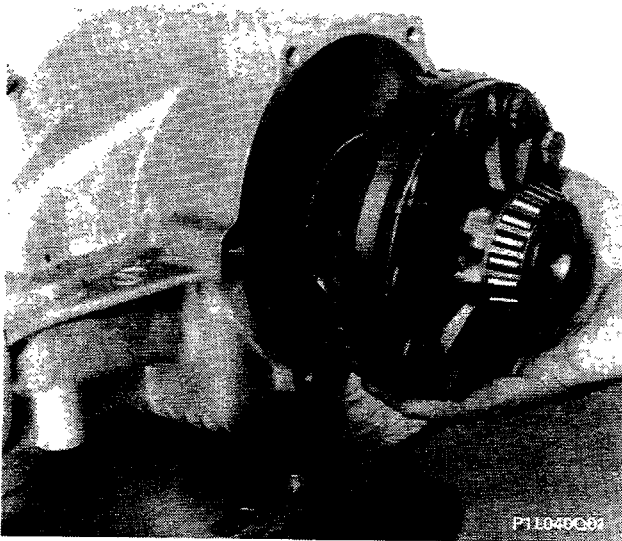

**CHECKING PINION - CROWN-  
WHEEL BACKLASH**

**Fitting differential unit in casing**

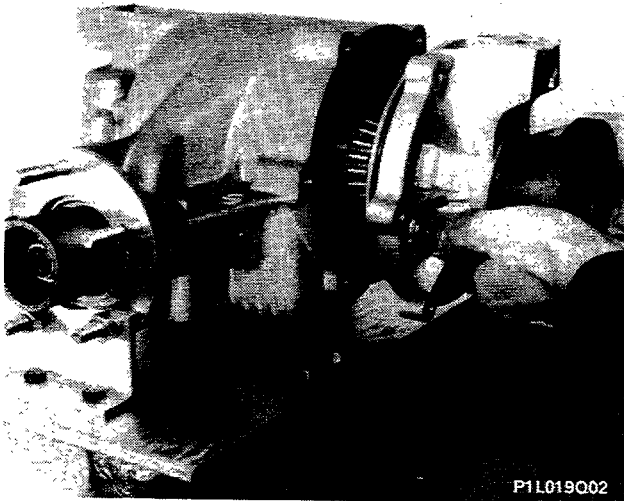

**Fitting left cover on differential casing**

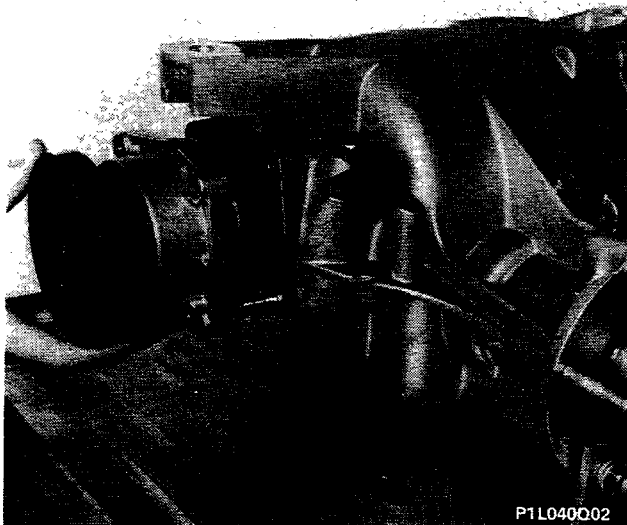

**Fitting right cover on differential casing**

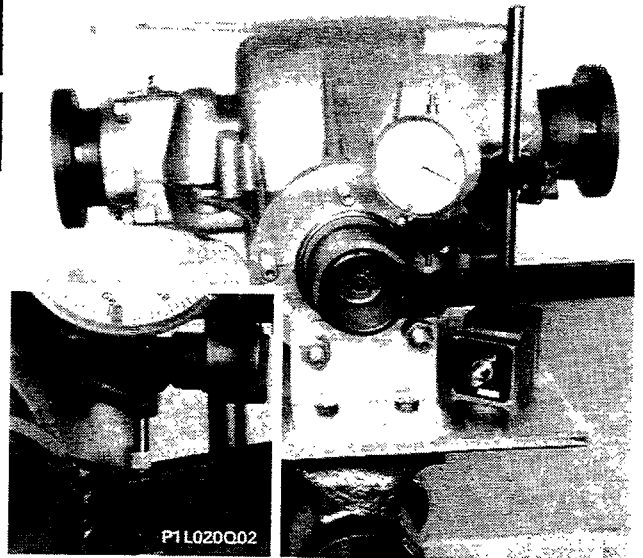

**Checking and adjusting pinion backlash**

If backlash is less than or greater than specified, the crownwheel must be moved closer to or further away from the pinion by adjusting shim thickness, taking care to maintain overall value calculated during adjustment of crown-wheel rolling torque.

**CHECKING AND ADJUSTING BEVEL PINION AND CROWN WHEEL TOOTH CONTACT PATTERN**

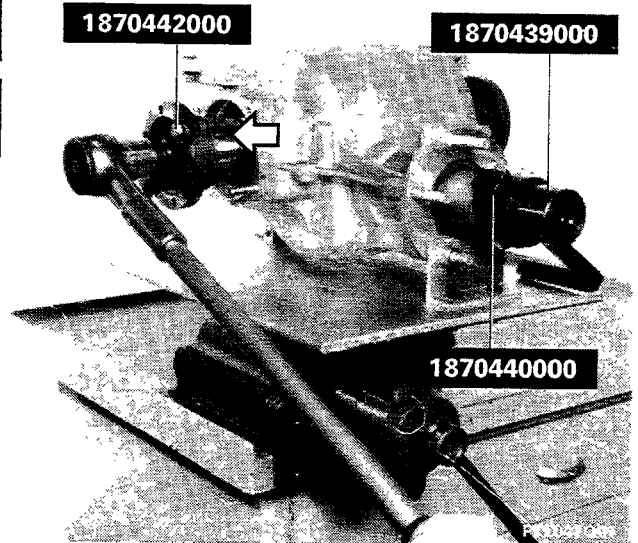

**Checking contact pattern of pinion-crownwheel teeth on drive and coast sides**

To carry out this check, first fit sleeve (arrowed) to lock right half shaft.

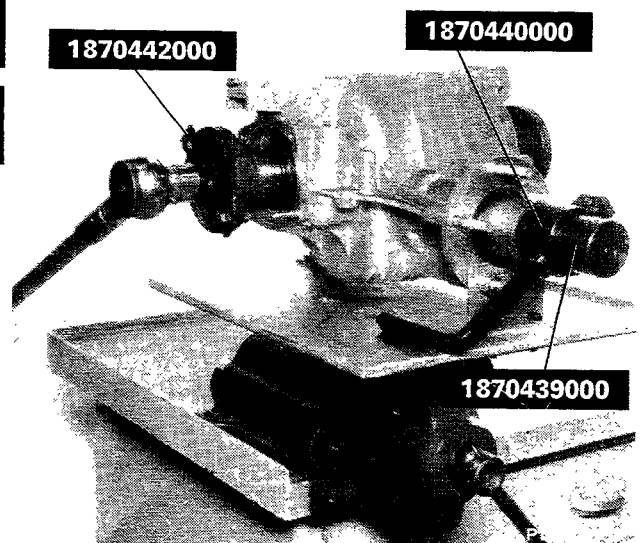

## 27.

DRIVE SIDE

COAST SIDE

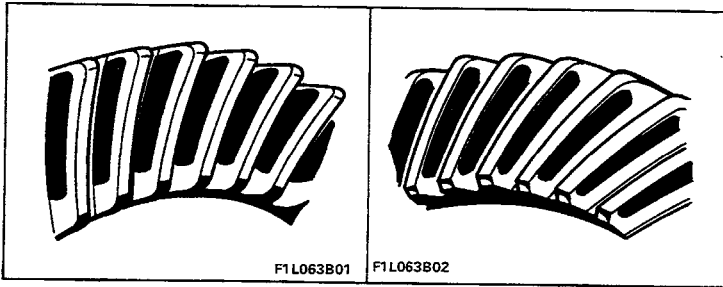

### Correct mesh

The contact pattern must be uniformly distributed over both tooth faces, i.e. drive and coast.

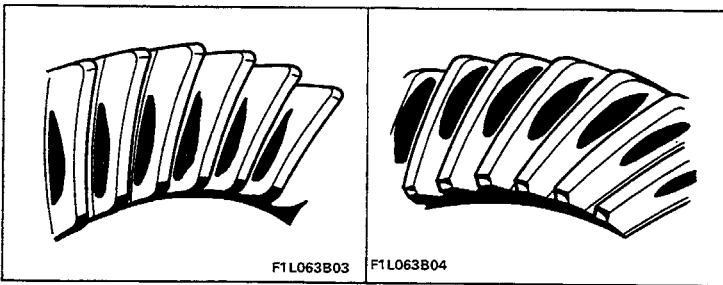

### Incorrect mesh

**Drive side:** contact of toe of tooth and toward centre.

**Coast side:** contact of heel of tooth and towards centre.

Move pinion out of mesh using thinner thrust ring

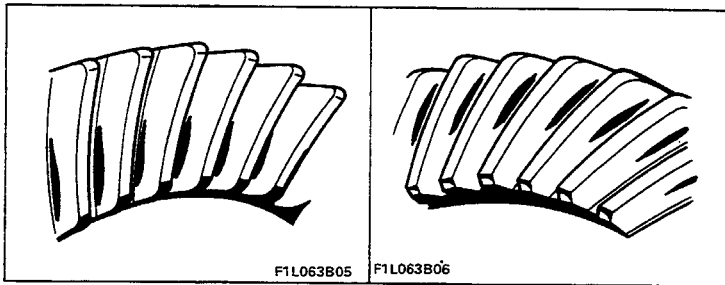

### Incorrect contact

**Drive side:** toe contact, localised at root.

**Coast side:** heel contact, localised at root.

Move pinion out of mesh using thinner thrust ring.

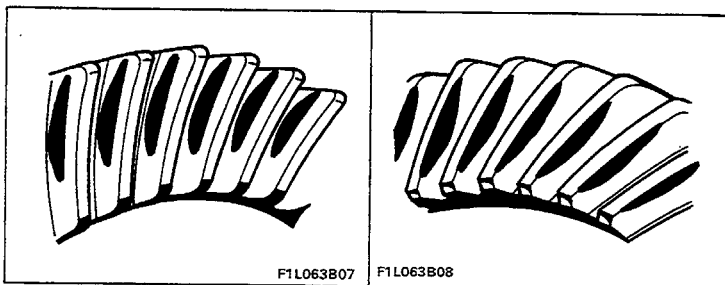

### Incorrect contact

**Drive side:** contact at heel and towards centre of tooth

**Coast side:** contact at toe and towards centre of tooth.

Move pinion into mesh using thicker thrust ring.

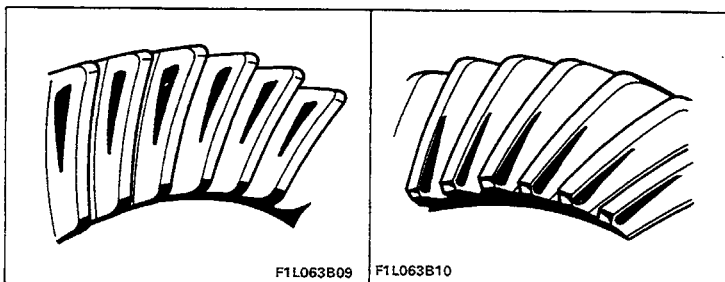

### Incorrect contact

**Drive side:** heel contact, localised on crest of tooth.

**Coast side:** contact on toe, localised on crest of tooth.

Move pinion into mesh, using thicker thrust ring.

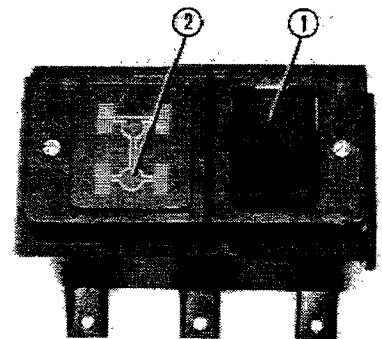
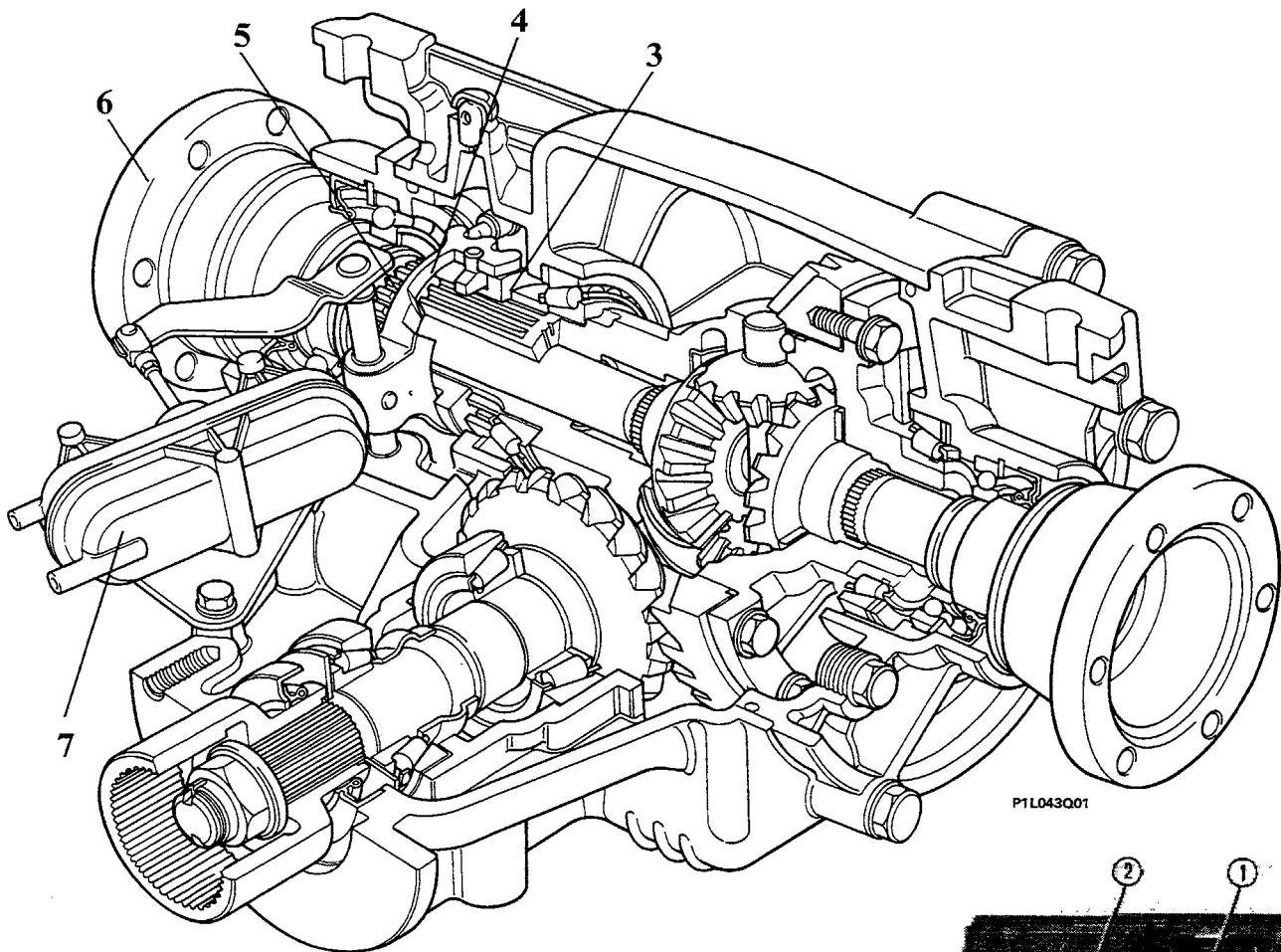

*In all above cases, unit must be removed. When refitting, repeat pinion-crownwheel backlash adjustment.*

**Differential lock**

1. Differential lock control button
2. Differential lock warning light
3. Engagement sleeve
4. Fork
5. Gear
6. Right differential shaft
7. Pneumatic actuator

The differential lock is located inside the differential casing. It consists of engagement sleeve (3) with spur teeth that slides upon a splined, cylindrical section of the differential casing. When operated by fork (4) it engages with gear (5) integral with right differential shaft (6) so that the shaft is fixed to the case. The effect of the differential is thus cancelled. The engagement fork is operated by pneumatic actuator (7) and linkage. Engagement is controlled via pushbutton (1), and the warning light comes on when lock is engaged. Both pushbutton and warning light are located on the car control panel.

The device must be engaged only when one of the car's rear wheels is not gripping due to muddy or slippery ground and a skid is feared. The lock must be used only in cases of absolute necessity and pushbutton immediately returned to rest position.

Engagement should be carried out when the car is at a standstill or moving slower than 50 kph.



# Rear differential

## Tightening torques

# DELTA-PRISMA 4WD

27.

PART	Thread size	Tightening torque	MODEL	
		daNm	DELTA	PRISMA

Staked nut retaining pinion	M 20 x 1.5	★	●	●
Crownwheel retaining bolt	M 10 x 1.25	8.8		●
Crownwheel retaining bolt	M 10 x 1.25	8	●	
Fork retaining bolt	M 6 x 1	1.1		●
Male threaded plug for ratchet	M 12 x 1.25	8.5		●
Pushbutton switch	M 14 x 1.5	4		●
Tapered magnetic threaded oil drain plug	M 22 x 1.5	4.6	●	●
Bolt retaining left cover	M 10 x 1.25	5	●	●
Tapered threaded oil filler plug	M 22 x 1.5	4.6	●	●
Bolt retaining right cover	M 8 x 1.25	2.5	●	●
Nut for stud on right cover	M 8 x 1.25	2.5	●	●

★ Procedure for staking pinion nut is described on page 18 for Delta models and on page 39 for Prisma models